

VENTILATION KITS AND COMPONENTS CATALOGUE

General Venting

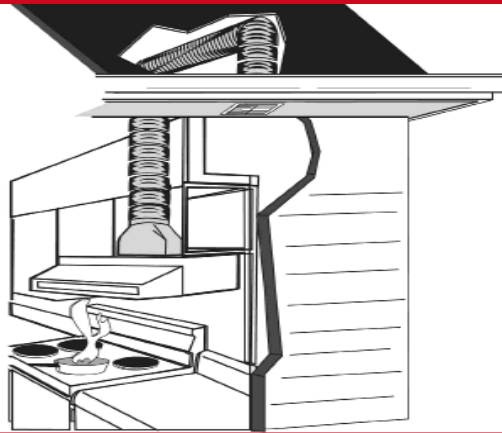

Ducted Heating Vents



Rangehood Venting



Air Transfer



Ducting & Accessories

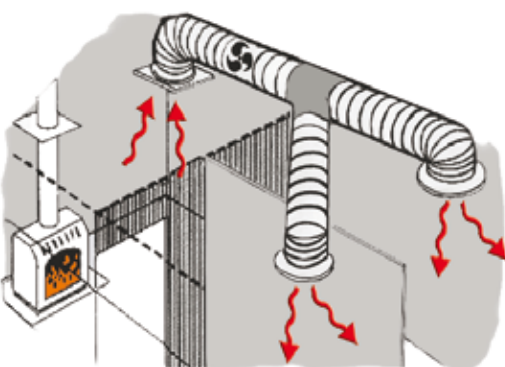

Clothes Dryer Venting

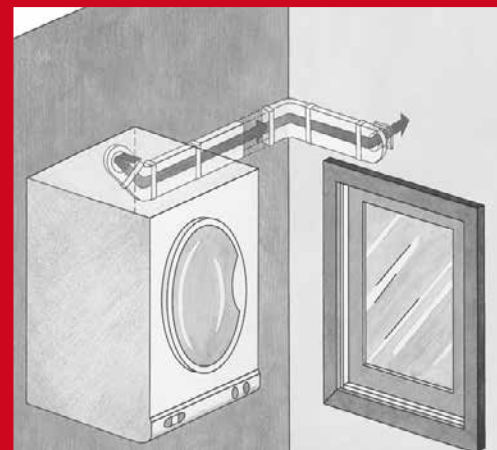

CONTENTS

Rangehood

Top Adaptors	4
Semi-Rigid Venting Kits	5 - 9
Rectangular Ducting & Components	10-11

Clothes Dryer

DVS - In-Laundry Ducting Kits	12
DVS - External Ducting Kits	13
DVS - Individual Components	14 - 15
Internal Venting	16
External Venting	17
Skinny Duct Kits	18

Air Transfer

Internal to External	19
Room to Room kits & Components	19
In-Line Fans, Inlet & Outlet Vents	20

Floor Venting

Polycarbonate 300 x 100mm	21
Polycarbonate - 350x150mm	21
ABS Plastic - 300x100mm	22
Bettavent®	23
Air Deflectors	23
Metal & Wooden floor Registers	24
Floor Duct extension Kit	25
Floor Vent Boots	25
Branch Take-Offs	26

CONTENTS

Vents & Grills

Plastic - Wall	27
Stainless Steel - Wall	28
Under Eave	29
Roof	30
Ceiling Inlet/outlets	31
Multi Directional Ceiling outlets	32
Ventilation Grills - Standard Grills	33
Ventilation Grills - Stainless Steel	34

Ducting & Accessories

Insulated	36
Semi-Rigid	35
SUpurr FLEX	35
Piping - "Clip Seam"	36
Flashing	37
Clamps	38
Increasesers & Elbows	39
Draft Blockers	39
Vent Brush	39

Storage Systems

Stack A Bin	40
Link A Bin	41
Tilt Bins	41

NOTICE:

The information and recommendations set forth in this catalogue (hereinafter "Information") are presented in good faith and believed to be correct. JPM International makes no representations as to the completeness or accuracy thereof. Information is supplied upon the condition that the persons receiving same will make their own determination as to its suitability for their purposes prior to use. In no event will JPM International be responsible for damages of any nature whatsoever resulting from the use of or reliance upon Information. JPM International also reserves the right to delete products, alter prices and product specifications without notice.

RANGEHOOD VENTING

Have you ever wondered where all the excessive cooking by-products like fats, grease and steam go when you are using your rangehood?

Often you may find that your rangehood is being vented into the roof space - where over time - this can not only create an invitation for vermin to enter your home to feed on the cooking residues, but also greatly increases the risk and spread of fire within your home. Elsewhere in the world - and becoming an increasing requirement here in Australia - it is legislated that appliances such as rangehoods, be vented outside to protect your greatest assets - your family and your home.

JPM have compiled a range of complete kit formats to safely expel the unwanted fumes and odours outside via 3 external methods ie... Wall, Eave and Roof.

We also pride ourselves on offering a superior fire and heat resistant range of Australian approved, flexible ducting - AO Semi-Rigid aluminium ducting & SUPurr-FLEX Multi-layered, metallic ducting.

This coupled with the many innovative external vents and component options, ensures that the likelihood of a tragedy occurring by insufficiently venting your rangehood is all but eliminated.

Also available is the FlatPack Low profile Duct System of fire retardant, self-extinguishing, Rectangular PVC Ducting and components that allows an efficient venting option for installations that have minimal space allowances.

With two size systems, 204mm x 66mm (replacing 125mm to 150mm round ducting) or 180mm x 95mm (replacing 150mm to 200mm round ducting) offering greater options to vent in-between floors, wall spaces, or on the top of kitchen cabinets in a smooth, efficient manner that is less conspicuous than other forms of ducting.

Purchase our universal wall vent kit or compile your own venting configuration from the many components available in the FlatPack System and the various external venting options as listed throughout this catalogue.

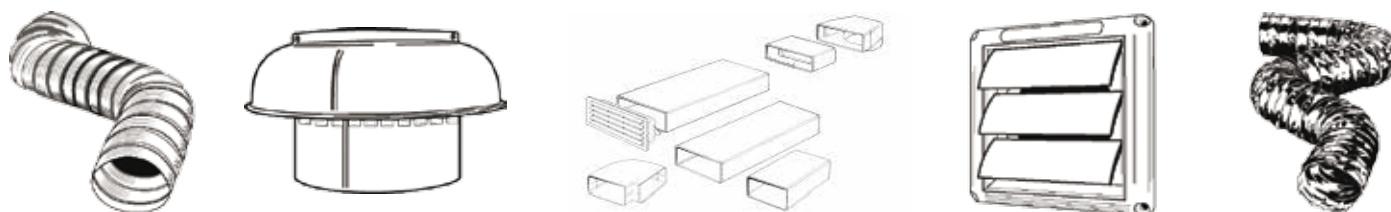

Deflect-o rangehood flange adaptor 125mm



Contents & Features...

Made from galvanised steel for maximum fire protection. Suits Outlets 125mm in diameter and less.

- Alcohol Wipe for surface cleaning prior to attachment
- Fire retardant/ heat resistant adhesive ring



SKU	Model No.	Description	Diameter	Dimensions	Carton Qty	Barcode	S.S.P
	RHF5R	R/HOOD FLANGE ADAPT.	125mm	H50mm x 13mm flange	6	9317468671484	27.00

Deflect-o rangehood flange adaptor 150mm



Contents & Features...

Made from galvanised steel for maximum fire protection. Suits outlets 150mm in diameter and less.

- Alcohol Wipe for surface cleaning prior to attachment
- Fire retardant/ heat resistant adhesive ring



SKU	Model No.	Description	Diameter	Dimensions	Carton Qty	Barcode	S.S.P
	RHF6R	R/HOOD FLANGE ADAPT.	150mm	H50mm x 13mm flange	6	9317468671491	30.00

Deflect-o rectangular to round adaptor



Contents & Features...

Full aluminium construction for maximum fire and corrosion protection. Suits rectangular outlets L290mm x W130mm or less.

- Alcohol Wipe for surface cleaning prior to attachment
- Fire retardant/ heat resistant adhesive strips



SKU	Model No.	Description	Diameter	Dimensions	Carton Qty	Barcode	S.S.P
	RHA5	R/HOOD ADAPTOR	125mm	H110mm x L290mm x W130mm	6	9317468671477	36.00

Eave Vent Kits

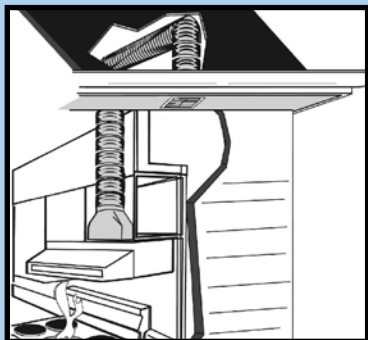

Deflect-o Eave venting kits are ideal for ventilation options requiring bends to navigate around obstacles within the roof cavity.

Supplied with the most efficient type of flexible ducting - Semi-Rigid aluminium ducting holds its full diameter and form when bent into shape, and also offers a superior temperature range to that of flexible foil type ducting.

Ducting expands to a straight length of 3000mm and should be extended in sections from the centre - out to each end.

The Grill Vent consists of a calcium filled, polypropylene plastic with UV stabilisers and comes with a removable front grill and mesh for ease of cleaning. Alternatively the stainless steel eave vent boasts quality construction and can be combined with optional cinder mesh suitable for bushfire prone areas.



Deflect-o 125mm Diameter Rangehood kit

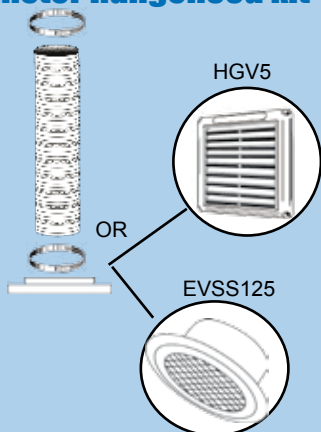

Contents & Features...

- HGVS125 - Grill Vent C/w Screen 125mm OR EVSS125 Eave vent Stainless Steel
- AO503MR - 3000mm Semi-Rigid aluminium ducting
- MC5 - Metal worm drive clamps (x2)
- Alternative option to roof penetration - no leaks
- Effective and unobtrusive
- Overall maximum length of 3000mm - less with bends
- Extend reach with additional duct, sleeve and clamps
- Installation by a professional is recommended



SKU	Model No.	Description	Diameter	Outlet	Barcode	S.S.P
	RHK125E	R/HOOD SEMI-RIGID KIT	125mm	PLASTIC	9317468658829	90.00
	RHK125ESS	R/HOOD SEMI RIGID KIT	125mm	STAINLESS STEEL	9317468661317	106.00

150mm Kit

As Above HGVS150 - Grill Vent C/w Screen 150mm OR EVSS150 Eave vent Stainless Steel

- AO603MR - 3000mm Semi-Rigid aluminium ducting
- MC6 - Metal worm drive clamps (x2)

SKU	Model No.	Description	Diameter	Outlet	Barcode	S.S.P
	RHK150E	R/HOOD SEMI-RIGID KIT	150mm	PLASTIC	9317468658867	99.00
	RHK150ESS	R/HOOD SEMI-RIGID KIT	150mm	STAINLESS STEEL	9317468661324	119.00

200mm Kit

As Above EVSS200B - Eave Vent Stainless Steel - 200mm

- AO803M - 3000mm Semi-Rigid aluminium ducting
- MC8 - Metal worm drive clamps (x2)

* 200mm eave vent is not supplied with cinder mesh

SKU	Model No.	Description	Diameter	Outlet	Barcode	S.S.P
	RHK200ESS	R/HOOD SEMI-RIGID KIT	200mm	STAINLESS STEEL	9317468658898	158.00

Universal Rangehood Venting Kit - Roof

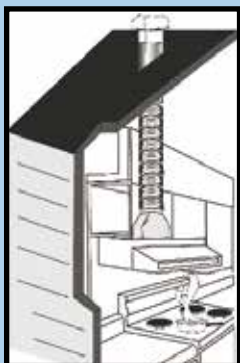

Deflect-o Universal Roof Cowl venting kits are ideal for ventilation options requiring bends to navigate around obstacles within the roof cavity.

These universal roof cowl kits are available for either tiled or metal roofs and are designed to adapt to both 125mm or 150mm rangehood outlets.

Supplied with the most efficient type of flexible ducting - Semi-Rigid aluminium ducting holds its full diameter and form when bent into shape, and also offers a superior temperature range to that of flexible foil type ducting.

The Roof Mushroom Cowl is a far superior option to the common type cowl - offering greater protection from birds, rain and rust.



Deflect-o universal Metal roof kit

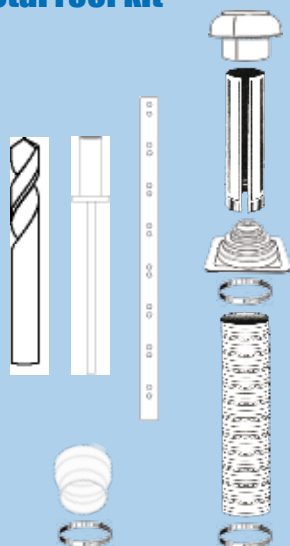

Contents & Features...

- RMC6 - Roof Mushroom Cowl - aluminium
- GSPS062430 - 30g. galvanised 610mm Clip-Seam Piping
- MFS4B - Metal roof flashing
- Bracing strap 900mm x 0.8mm - galvanised steel
- Rivets & drill bit - for attachments
- AO603MR - 3000mm Semi-Rigid aluminium ducting
- AO503M - 125mm x 300mm Semi-Rigid aluminium ducting
- DIRB65 - 125mm to 150mm Duct increaser
- MC6 - Metal worm drive clamps 150mm
- MC5 - Metal worm drive clamps 125mm

- Overall maximum length of 3600mm
- Extend reach with additional duct, sleeve and clamps
- Installation by a professional is recommended



SKU	Model No.	Description	Diameter	Outlet	Barcode	S.S.P
	RHKMR65	R/HOOD SEMI-RIGID KIT	UNIVERSAL	METAL ROOF	9317468658751	165.00

Deflect-o universal Tile roof kit

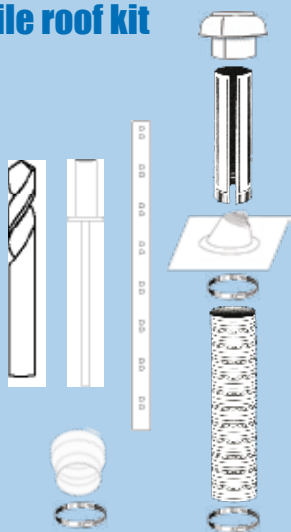

Contents & Features...

- RMC6 - Roof Mushroom Cowl - aluminium
- GSPS062430 - 30g. galvanised 610mm Clip-Seam Piping
- MFAL1B - Tile roof flashing
- Bracing strap 900mm x 0.8mm - galvanised steel
- Rivets & drill bit - for attachments
- AO603MR - 3000mm Semi-Rigid aluminium ducting
- AO503M - 125mm x 300mm Semi-Rigid aluminium ducting
- DIRB65 - 125mm to 150mm Duct increaser
- MC6 - Metal worm drive clamps 150mm
- MC5 - Metal worm drive clamps 125mm

- Overall maximum length of 3600mm
- Extend reach with additional duct, sleeve and clamps
- Installation by a professional is recommended



SKU	Model No.	Description	Diameter	Outlet	Barcode	S.S.P
	RHKTR65	R/HOOD SEMI-RIGID KIT	UNIVERSAL	TILE ROOF	9317468658768	200.00

Roof Mushroom Cowl Kits

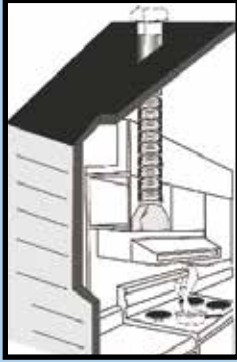

Deflect-o Roof Cowl venting kits are ideal for ventilation options requiring bends to navigate around obstacles within the roof cavity.

Supplied with the most efficient type of flexible ducting - Semi-Rigid aluminium ducting holds its full diameter and form when bent into shape, and also offers a superior temperature range to that of flexible foil type ducting.

Ducting expands to a straight length of 3000mm and should be extended in sections from the centre - out to each end.

The Roof Mushroom Cowl is a far superior option to the common type cowl - offering greater protection from birds, rain and rust.



Deflect-o 125mm Diameter Kit

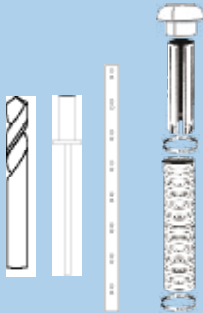

Contents & Features...

- RMC5 - Roof Mushroom Cowl - aluminium
- GSPS052430 - 30g. galvanised 610mm Clip-Seam Piping
- Bracing strap 900mm x 0.8mm - galvanised steel
- Rivets & drill bit - for attachments
- AO503MR - 3000mm Semi-Rigid aluminium ducting
- MC5 - Metal worm drive clamps
- Overall maximum length of 3600mm
- Extend reach with additional duct, sleeve and clamps
- **Roof specific flashing required See page: 37**
- Installation by a professional is recommended



SKU	Model No.	Description	Diameter	Outlet	Barcode	S.S.P
	RHK125T	R/HOOD SEMI-RIGID KIT	125mm	ROOF	9317468658812	135.00

Deflect-o 150mm Diameter Kit

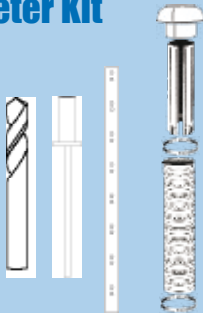

Contents & Features...

- RMC6 - Roof Mushroom Cowl - aluminium
- GSPS062430 - 30g. galvanised 610mm Clip-Seam Piping
- Bracing strap 900mm x 0.8mm - galvanised steel
- Rivets & drill bit - for attachments
- AO603MR - 3000mm Semi-Rigid aluminium ducting
- MC6 - Metal worm drive clamps
- Overall maximum length of 3600mm
- Extend reach with additional duct, sleeve and clamps
- **Roof specific flashing required See page: 37**
- Installation by a professional is recommended



SKU	Model No.	Description	Diameter	Outlet	Barcode	S.S.P
	RHK150T	R/HOOD SEMI-RIGID KIT	150mm	ROOF	9317468658850	145.00

RHK200T

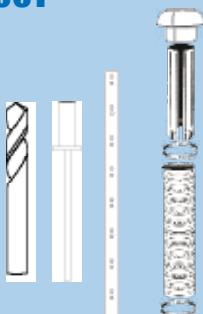

Contents & Features...

- RMC8 - Roof Mushroom Cowl - aluminium
- GSPS082430 - 30g. galvanised 610mm Clip-Seam Piping
- Bracing strap 900mm x 0.8mm - galvanised steel
- Rivets & drill bit - for attachments
- AO803M - 3000mm Semi-Rigid aluminium ducting
- MC8 - Metal worm drive clamps
- Overall maximum length of 3600mm
- Extend reach with additional duct, sleeve and clamps
- **Roof specific flashing required See page: 37**
- Installation by a professional is recommended



SKU	Model No.	Description	Diameter	Outlet	Barcode	S.S.P
	RHK200T	R/HOOD SEMI-RIGID KIT	200mm	ROOF	9317468658775	175.00

Through The Wall Kits

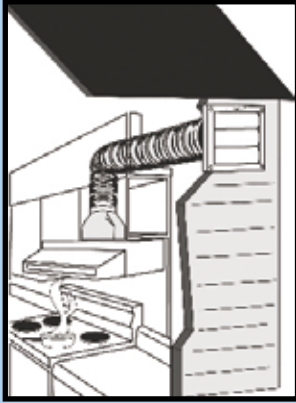

Deflect-o Wall venting kits are ideal for ventilation options requiring bends to navigate around obstacles within wall or roof cavities.

Supplied with the most efficient type of flexible ducting - Semi-Rigid aluminium ducting holds its full diameter and form when bent into shape, and also offers a superior temperature range to that of flexible foil type ducting.

Ducting expands to a straight length of 3000mm and should be extended in sections from the centre - out to each end.

The Wall Vent consists of a calcium filled, polypropylene plastic with UV stabilisers or stainless steel.

The gravity louvres allow air to exhaust, and shut to prevent the entry of back drafts, birds and vermin when not in use



Deflect-o 125mm Diameter kit

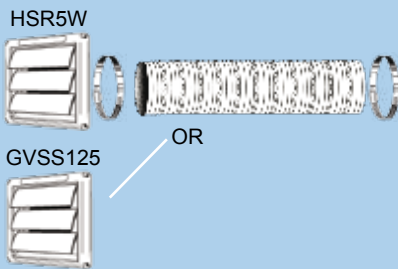

Contents & Features...

- HSR5W - Wall Vent plastic, gravity louvred
- or GVSS125 Wall Vent stainless steel gravity louvred
- AO503MR - 3000mm Semi-Rigid aluminium ducting
- MC5 - Metal worm drive clamps
- Overall maximum length of 3000mm
- Shorten ducting length with sharp knife if required
- Extend reach with additional duct, sleeve and clamps
- Installation by a professional is recommended



SKU	Model No.	Description	Diameter	Outlet	Barcode	S.S.P
	RHK125W	R/HOOD SEMI-RIGID KIT	125mm	PLASTIC	9317468658836	90.00
	RHK125WSS	R/HOOD SEMI RIGID KIT	125mm	STAINLESS STEEL	9317468661331	123.00

150mm Kit

As Above with HSR6W plastic vent OR GVSS150 Stainless Steel Vent .

- AO603MR - 3000mm Semi-Rigid aluminium ducting
- MC6 - Metal worm drive clamps

SKU	Model No.	Description	Diameter	Outlet	Barcode	S.S.P
	RHK150W	R/HOOD SEMI-RIGID KIT	150mm	PLASTIC	9317468658874	100.00
	RHK150WSS	R/HOOD SEMI RIGID KIT	150mm	STAINLESS STEEL	9317468661348	137.00

200mm Kit

As Above with MV200 plastic vent Or GVSS200B Stainless Steel Vent.

- AO803MR - 3000mm Semi-Rigid aluminium ducting
- MC8 - Metal worm drive clamps

SKU	Model No.	Description	Diameter	Outlet	Barcode	S.S.P
	RHK200W	R/HOOD SEMI-RIGID KIT	200mm	PLASTIC	9317468658874	130.00
	RHK200WSS	R/HOOD SEMI RIGID KIT	200mm	STAINLESS STEEL	9317468661355	220.00

Universal Rangehood Venting Kit - Wall/Eave

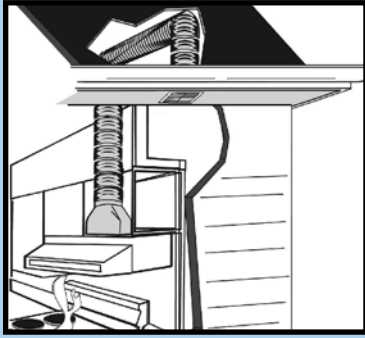

Deflect-o Universal Eave venting kits are ideal for ventilation options requiring bends to navigate around obstacles within the roof cavity. Supplied with a duct increaser, this kit is universal to fit both 125mm or 150mm rangehood outlets.

Supplied with the most efficient type of flexible ducting - Semi-Rigid aluminium ducting holds its full diameter and form when bent into shape, and also offers a superior temperature range to that of flexible foil type ducting.

Ducting expands to a straight length of 3000mm and should be extended in sections from the centre - out to each end.

The Grill Vent consists of a calcium filled, polypropylene plastic with UV stabilisers and comes with a removable front grill and mesh for ease of cleaning.



Deflect-o Universal Wall/Eave kit

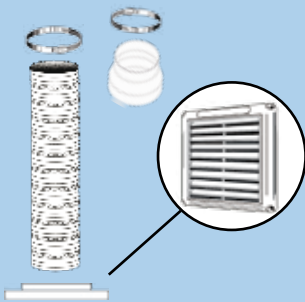

Contents & Features...

- HGV6 - Grill Vent C/w Screen 150mm
- AO603MR - 3000mm Semi-Rigid aluminium ducting
- AO503M - 125mm x 300mm Semi-Rigid aluminium ducting
- DIRB65 - 125mm to 150mm Duct increaser
- MC6 - Metal worm drive clamps 150mm
- MC5 - Metal worm drive clamps 125mm

- Alternative option to roof penetration - no leaks
- Effective and unobtrusive
- Overall maximum length of 3000mm - less with bends
- Extend reach with additional duct, sleeve and clamps
- Installation by a professional is recommended



SKU	Model No.	Description	Diameter	Outlet	Barcode	S.S.P
	RHKE65	R/HOOD SEMI-RIGID KIT	UNIVERSAL	WALL/EAVE	9317468658652	120.00

Draft Blocker

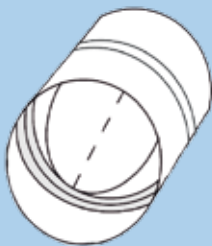

Contents & Features...

Manufactured with an internally, spring-loaded butterfly damper that allows air to flow through in one direction and close when the venting system is not in use.

These in-line draft blockers are ideally installed in vertical venting systems such as rangehoods, exhausting out through the roof.

*Hint - Maintain at regular intervals to ensure there is no blockage.



SKU	Model No.	Description	Duct diameter	Ext. Size	Made from	Carton Qty	Barcode	S.S.P
	DBV100	DRAFT BLOCKER VALVE	100mm	88 x 100mm	Galvanised steel	24	9317468004657	17.50
	DBV125	DRAFT BLOCKER VALVE	125mm	88 x 125mm	Galvanised steel	24	9317468004664	19.50
	DBV150	DRAFT BLOCKER VALVE	150mm	88 x 150mm	Galvanised steel	12	9317468004671	22.50
	DBV200	DRAFT BLOCKER VALVE	200mm	88 x 200mm	Galvanised steel	12	9317468004688	27.50

Increasesers/Reducers



Contents & Features...

Designed in gradual-staged sections to minimise backflow pressures when reducing diameters.

Ideal for increasing/decreasing ducting diameters

May be used in conjunction with Clip-seam piping

- Internally smooth for maximum airflow efficiency
- May be clamped for ducting - or riveted for pipe attachment



SKU	Model No.	Description	Joins	Ext. Size	Made from	Carton Qty	Barcode	S.S.P
	DIRB54	DUCT INCREASER	100 - 125mm	L150mm	Aluminium	12	079916908229	8.50
	DIRB65	DUCT INCREASER	125 - 150mm	L150mm	Aluminium	6	079916908250	12.50
	DIRB86	DUCT INCREASER	150 - 200mm	L180mm	Galvanised steel	6	079916908281	26.00

Low Profile Rectangular flatpack ducting & Accesories

This kit offers a low profile rectangular ducting alternative to standard round aluminium ducting. This system is ideal for installations with minimal space allowances.

- System 204 is 204mm x 60mm replacement for 125-150mm round ducting
- Modular slide together compnents for quick and easy installation
- Light weight self - extinguishing PVC complies with BCA vol 1 with ref to AS4254-1995
- Can be painted to blend in with decor

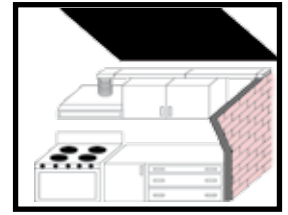

Rectangular ducting



Features...

Made from white, flame-retardant, self-extinguishing plastic.



SKU	Model No.	Description	Carton Qty	Barcode	S.S.P
	HAD201-1	SYSTEM 204 - FLATPACK DUCT 204 x 60 x 1000mm	6	9317468931533	38.00
	HAD201	SYSTEM 204 - FLATPACK DUCT 204 x 60 x 2000mm	6	9317468931526	72.00

Duct Connector



Features...

Connects 2 channel duct pieces together for extended length.



SKU	Model No.	Description	Carton Qty	Barcode	S.S.P
	HAD202	SYSTEM 204 - DUCT CONNECTOR	6	9317468004749	8.00

45° Horizontal Bend



Features...

Connects to channel duct and redirects air at a 45 degree angle.



SKU	Model No.	Description	Carton Qty	Barcode	S.S.P
	HAD210	SYSTEM 204 - 45° HORIZONTAL BEND	6	9317468004770	16.00

Elbow Bends



Features...

Rotating 150mm ø spigot for optional offset attachment of round, vertical pipe or ducting. Transition from round to rectangle.

- W210mm x D66mm x L240mm - Internal dimensions



SKU	Model No.	Description	Diameter	Carton Qty	Barcode	RRP
	HAD204	RECTANGULAR SYSTEM 204 ROTATING ELBOW BEND	150mm	6	9317468004787	16.00

90° Horizontal Bend



Features...

Connects to channel duct and redirects air at a right angle.



SKU	Model No.	Description	Carton Qty	Barcode	S.S.P
	HAD203	SYSTEM 204 - 90° HORIZONTAL BEND	6	9317468004725	16.00

Horizontal T piece



Features...

Connects to channel duct and redirects air L/R at a right angles .



SKU	Model No.	Description	Carton Qty	Barcode	S.S.P
	HAD205	SYSTEM 204 HORIZONTAL T PIECE	6	9317468004794	26.00

Round to flat straight adaptor



Features...

Connects to 125mm round outlets and converts to channel duct.



SKU	Model No.	Description	Carton Qty	Barcode	S.S.P
	HAD207	SYSTEM 204 - 125MM RND-RECT ADAPTOR	6	9317468004763	\$16.00

Round Duct Reducer



Features...

Designed in gradual-staged sections to minimise backflow pressures when reducing diameters.

Ideal for increasing/decreasing ducting diameters

- Internally smooth for maximum airflow efficiency



SKU	Model No.	Description	Joins	Ext. Size	Made from	Carton Qty	Barcode	S.S.P
	DIRB54	DUCT INCREASER	100 - 125mm	L150mm	Aluminium	12	079916908229	8.50
	DIRB65	DUCT INCREASER	125 - 150mm	L150mm	Aluminium	6	079916908250	12.50

Flat Duct Clip



Features...

Use this channel clip to secure your ducting to the wall or ceiling.

Simply screw the clip in, then click the ducting in place.



SKU	Model No.	Description	Carton Qty	Barcode	S.S.P
	VKC5610	SYSTEM 204 - DUCT CLIP	6	9317468004862	6.50

Wall Plate



Features...

Use this wall plate to cover up any imperfections from the cut-out in the wall or ceiling. This will provide for an attractive finish to your ventilation system.



SKU	Model No.	Description	Carton Qty	Barcode	S.S.P
	VKC5601	SYSTEM 204 - WALL PLATE	6	9317468004879	6.50

Outlet Grill

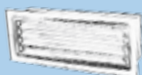

Features...

Connects to channel duct as an external fixed louvred vent.

Sized to easily replace existing brick.

- Quality Stainless Steel construction



SKU	Model No.	Description	External Size (W x H)	Carton Qty	Barcode	S.S.P
	SSE204	SYSTEM 204 - OUTLET GRILL	225 x 80mm	6	9317468001984	26.00

Universal Rectangle Duct Rangehood Wall Venting Kit

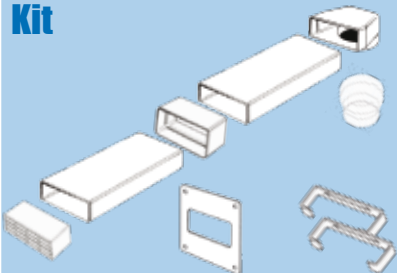

Contents & Features...

- Airbrick (brown)
- 1.0M Flatpack channel (x2)
- Channel connector
- Channel clip (x2)
- Rectangular wall plate
- Rotating Elbow Bend 125/150mm
- 150mm x 700mm Semi-Rigid aluminium ducting

Overall maximum length of 2000mm

Shorten ducting length with sharp hacksaw if required

Extend reach with additional channel and channel connectors

Installation by a professional is recommended



SKU	Model No.	Description	Outlet	Barcode	S.S.P
	LFRHKW	FLAT DUCT R/HOOD WALL VENTING KIT	WALL	9317468658577	210.00

Deflect-o inlet/outlet kit

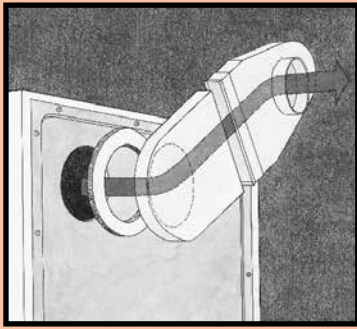

Contents & Features...

This kit is ideal for dryers backing on to an external wall. May be extended using DVS components and vented outside using a DVS1 Through the Wall kit.

- DVSi - Low profile Inlet
- DVSWO - Low profile Wall Outlet
- DVSGR - Double sided, self adhesive gasket ring
- DVSSC - Saddle Clamp supports DVSi to rear of dryer
- DVSDT - Optional joint sealer tape
- Includes - Double sided adhesive pads for wall mount option
- Offers 360° installation option that fits under wall bracket
- Offers 275mm Inlet/Outlet centre to centre reach



SKU	Model No.	Description	Barcode	S.S.P
	DVS2	DRYER VENT SYS. INLET/OUTLET KIT	9317468672146	59.00

Deflect-o Rectangular to round kit

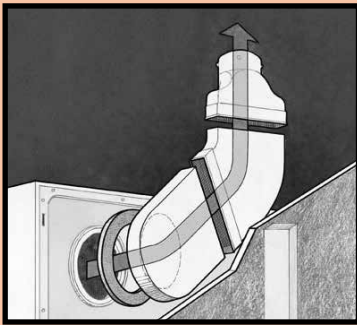

Contents & Features...

This kit reaches the nearest edge of the dryer, where it is continued outside via flexible duct, DVSA - duct Adaptor and any DVS external ducting option.

- DVSi - Low profile Inlet
- DVSE - Low profile 45° Elbow
- DVSO - Low profile to 100mm round Outlet
- DVSGR - Double sided, self adhesive gasket ring
- DVSSC - Saddle Clamp supports DVSi to rear of dryer
- DVSDT - Optional joint sealer tape
- Includes - Double adhesive pads for wall mount option
- Dryer top, side or bottom installation option
- Offers 275mm reach from inlet centre to machine's edge



SKU	Model No.	Description	Barcode	S.S.P
	DVS3	DRYER VENT SYS. RECT-100mm RND KIT	9317468672016	72.00

Deflect-o corner duct kit

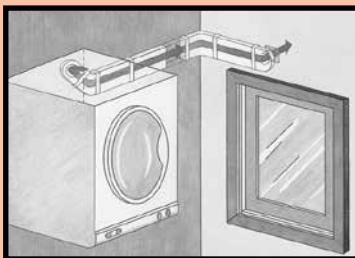

Contents & Features...

This kit is ideal for dryers positioned on an internal wall that need to navigate around a 90° corner to ventilate outside via a secondary Wall, or Eave/ Roof via the ceiling.

Use with DVS1 - Through the Wall kit, to vent your dryer outside through an external wall.

Use with a DVS4 - Ceiling to Eave kit, to vent your dryer outside via the eave.

Use with a DVS6 - Ceiling to Roof kit to vent your dryer outside via the ceiling.

- DVSi - Low profile Inlet
- DVSE - Low profile 45° Elbow
- DVSC - Low profile 90° Internal Corner Duct
- DVSWO - Low profile Wall Outlet
- DVSD - Low profile 300mm extension Duct (x3)
- DVSGR - Double sided, self adhesive gasket ring
- DVSSC - Saddle Clamp (x4) supports ducting to wall or dryer
- DVSDT - Optional joint sealer tape
- Includes - Double adhesive pads for wall mount option
- Vertical or horizontal installation that can fit under wall bracket
- Offers 1250mm maximum reach from inlet centre to wall corner



SKU	Model No.	Description	Barcode	S.S.P
	DVS5	DRYER VENT SYS. CORNER DUCT KIT	9317468672160	138.00

Deflect-o through wall kit

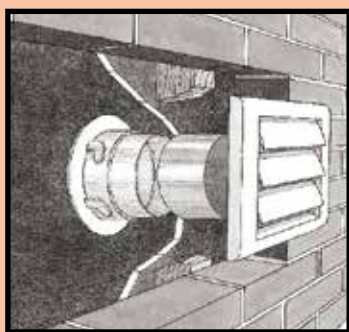

Contents & Features...

Accepts dryer exhaust from In-Laundry ducting option and securely vents outside.
Backflow control flaps eliminate the entry of birds and vermin.

- DVSP - Blank off Plug
 - DVSWP - Low profile Wall Plate
 - DP411S - 100mm x 280mm aluminium Clip-Seam Pipe
 - HSR4W - Wall Vent, plastic, gravity louvred
- OR GVSS100 stainless steel
- Ideal for new home installation as system may be plugged
 - Used in conjunction with an In-Laundry ducting option
 - Wall Plate accepts DVSA (flexible duct) as a turn and lock fit
 - Wall Plate accepts DVSWO (low profile duct) as a push fit



SKU	Model No.	Description	Barcode	S.S.P
	DVS1	DRYER VENT SYS. THRU-WALL KIT - PLASTIC	9317468672139	44.00
	DVS1SS	DRYER VENT SYS. THRU WALL KIT - STAINLESS STEEL	9317468919524	72.00

Deflect-o ceiling to eave kit

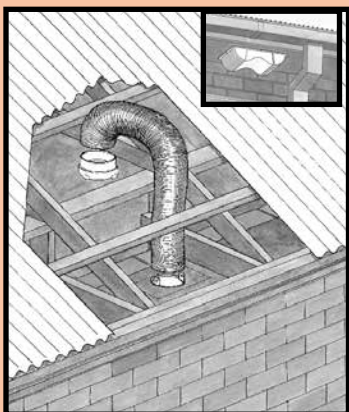

Contents & Features...

Accepts dryer exhaust from In-Laundry ducting option and securely vents outside.
Backflow control flaps eliminate the entry of birds and vermin.

- DVSP - Blank off Plug
 - DVSWP - Low profile Wall/ceiling Plate
 - MC4 - Metal worm drive clamp
 - AO403MR - 3000mm Semi-Rigid aluminium ducting
 - EVE - Under-Eave vent with backflow control flaps
- Ideal for new home installation as system may be plugged
 - Used in conjunction with an In-Laundry ducting option
 - Wall Plate accepts DVSA (flexible duct) as a turn and lock fit
 - Wall Plate accepts DVSWO (low profile duct) as a push fit
 - Offers 2.7 metre reach from ceiling outlet to eave



SKU	Model No.	Description	Barcode	S.S.P
	DVS4	DRYER VENT SYS. CEILING-EAVE KIT	9317468672153	72.00

Deflect-o ceiling to roof kit

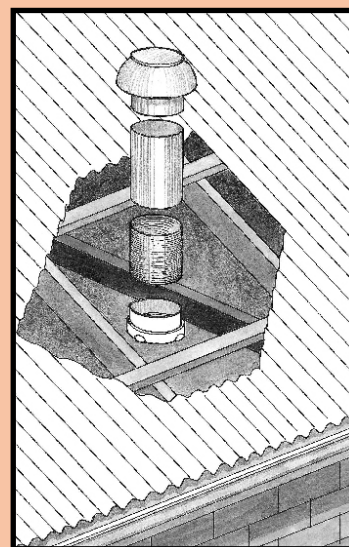

Contents & Features...

Accepts dryer exhaust from In-Laundry ducting option and securely vents outside.
Roof Mushroom Cowl offers protection from birds and rain.

- DVSP - Blank off Plug
 - DVSWP - Low profile Wall/ceiling Plate
 - MC4 - Metal worm drive clamp (x2)
 - AO403MR - 3000mm Semi-Rigid aluminium ducting
 - GSPS042430 - 30g. galvanised 610mm Clip-Seam Piping
 - RMC4 - Roof Mushroom Cowl
- Ideal for New home installation as system may be plugged
 - Used in conjunction with an In-Laundry Ducting option
 - Wall Plate accepts DVSA (flexible duct) as a turn and lock fit
 - Wall Plate accepts DVSWO (low profile duct) as a push fit
 - Offers 3 metre reach from ceiling outlet to roof

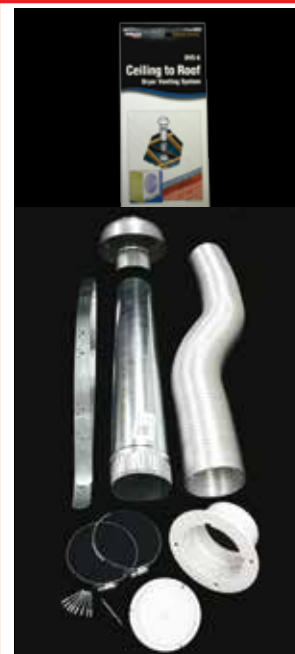

SKU	Model No.	Description	Barcode	S.S.P
	DVS6	DRYER VENT SYS. CEILING-ROOF KIT	9317468672177	115.00

Deflect-o flexible duct Adaptor/Connector



Features...

Designed to connect flexible ducting into the DVSWP - Wall Plate. Turns and locks in ducting for secure attachment, or use to extend flexible ducting by clamping 2 x 100mm lengths at either end.

- Flame retardant, self-extinguishing plastic.
- Suits 100mm flexible ducting
- L75mm x 95mm Internal Ø x External 99mm Ø



SKU	Model No.	Description	External Size	Carton Qty	Barcode	S.S.P
	DVSA	DRYER VENT SYS. ADAPTOR 100mm	L75 x 95mm	6	9317468672078	11.00

Deflect-o low profile Corner duct

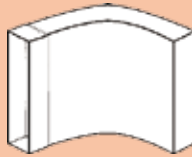

Features...

Extends a low profile ducting system around an internal corner. Navigates air from wall to wall, or wall to ceiling.

- Flame retardant, self-extinguishing plastic.
- Lightly sand and paint to match laundry decor - optional
- Extends 160mm on either side of a corner - W195mm x D47mm



SKU	Model No.	Description	External Size	Carton Qty	Barcode	S.S.P
	DVSC	DRYER VENT SYS. CORNER DUCT	W195 x D47mm	6	9317468672085	29.00

Deflect-o Low profile 300mm extension duct

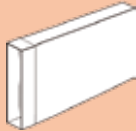

Features...

Extends a low profile ducting system by 300mm. Designed to fit between the dryer and a standard wall mounting bracket.

- Flame retardant, self-extinguishing plastic.
- Lightly sand and paint to match laundry decor - optional



SKU	Model No.	Description	External size	Carton Qty	Barcode	S.S.P
	DVSD	DRYER VENT SYS. DUCT 300mm EXT	L340 x W195 x D47mm	6	9317468672047	26.00

Deflect-o Low profile Elbow duct



Features...

Extends a low profile ducting system at a 45 angle. Designed to fit between the dryer and a standard wall mounting bracket.

- Flame retardant, self-extinguishing plastic.
- Lightly sand and paint to match laundry decor - optional



SKU	Model No.	Description	External Size	Carton Qty	Barcode	S.S.P
	DVSE	DRYER VENT SYS. ELBOW 45 DEG	L240 x W195 x D47mm	6	9317468672030	26.00

Deflect-o low profile Inlet duct



Features...

Connects to dryers with a flush, rear outlet via an adhesive gasket to begin a rectangular ducting system that fits between the dryer and a standard wall mounting bracket.

- Flame retardant, self-extinguishing plastic.
- L235mm x W195mm x D47mm



SKU	Model No.	Description	External Size	Carton Qty	Barcode	S.S.P
	DVSI	DRYER VENT SYS. INLET DUCT	L235 x W195 x D47mm	6	9317468672023	26.00

Deflect-o self adhesive gasket ring



Features...

DVSGR is a double sided heat resistant self adhesive ring for attached DVSI or DVSU around the dryer outlet or vent. 361 TAPE provides extra security of connection between DVS system components.



SKU	Model No.	Description	Carton Qty	Barcode	S.S.P
	DVSGR	DVS GASKET RING 175/135mm x 7mm	6	9317468672061	7.50
	361TAPE	CLOTH SEALING TAPE 4.5M x 48mm WHITE	6		4.75

Deflect-o low profile Transition Duct



Features...

Converts low profile ducting to a 100mm round outlet for the connection of fire rated, flexible ducting.
Shaped to fit on the edge of the dryer.

- Flame retardant, self-extinguishing plastic.
- L175mm x W195mm x D47mm



SKU	Model No.	Description	External Size	Carton Qty	Barcode	S.S.P
	DVSO	DRYER VENT SYS. OUTLET 100mm	L175 x W195 x D47mm	6	9317468672054	26.00

Saddle Clamp

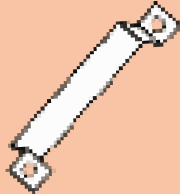

Features...

Galvanised for corrosion protection, this Saddle Clamp helps to secure the 190mm width of the DVSi - Inlet duct to the outlet on the back of the dryer, or when DVS components are mounted on a wall or ceiling surface.

- 3 Screw slots for attachment.
- 2 x 23mm Lugs on either end.



SKU	Model No.	Description	External Size	Carton Qty	Barcode	S.S.P
	DVSSC	DVS - SADDLE CLAMP BULK	L190 x W25mm	6	9317468672191	5.00

Deflect-o USA style Adaptor cone

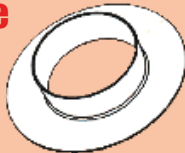

Features...

When attached to a DVSi - Inlet duct, the DVSU acts as a female inlet connection to accept the dryer's exhaust from appliances with proud, rear, spigot-type outlets. Eg. Maytag, Kleenmaid etc.

- Internal cone diameter tapers from 104mm front, to 99mm rear
- Includes DVS6R



SKU	Model No.	Description	External Size	Carton Qty	Barcode	S.S.P
	DVSU	DRYER VENT SYS. USA ADAPT. BULK	175mm rear flange diameter	6	9317468672009	24.00

Deflect-o low profile Waste Inlet



Features...

Designed to plug into dryer outlets with a 100mm internal cavity diameter to begin a rectangular ducting system.
Suits late model Electrolux, Westinghouse and Simpson dryers.

- Flame retardant, self-extinguishing plastic.
- 100mm x 40mm spigot



SKU	Model No.	Description	External Size	Carton Qty	Barcode	S.S.P
	DVSWi	DRYER VENT SYS. WASTE INLET	L200 x W190 x D43mm	6	9317468672122	29.00

Deflect-o low profile Wall outlet

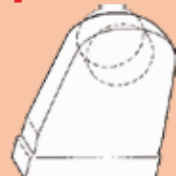

Features...

Designed to plug into the DVSWP - Wall Plate to continue outside through an External Ducting kit option
40mm. Female end accepts rectangular DVS components.

- Flame retardant, self-extinguishing plastic.
- 100mm x 40mm spigot.



SKU	Model No.	Description	External Size	Carton Qty	Barcode	S.S.P
	DVSWO	DRYER VENT SYS. WALL OUTLET	L240 x W195 x D47mm	6	9317468672108	29.00

Deflect-o Low Profile Wall Plate



Features...

Flush fitting Wall or Ceiling Plate, the DVSWP accepts the DVSA - Adaptor in a turn and lock fitting for flexible duct attachment, or the DVSWO - Wall Outlet when using low profile ducting.

- Supplied with removable blank-off Plug - 101mm Diameter
- Internal D40mm x 101mm Ø



SKU	Model No.	Description	External Size	Carton Qty	Barcode	S.S.P
	DVSWP	DRYER VENT SYS. WALL PLATE/PLUG	150mm outer flange diameter	6	9317468672115	29.00

Deflect-o dryer diverter assembly

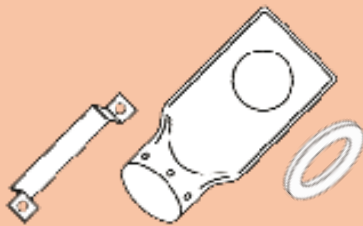

Features...

Use on rear vented dryers, where the centre of the outlet is within 160mm of the edge of the machine. Transfers into a 99mm round outlet for the attachment of fire rated, flexible ducting.

- Fits under a standard wall mounting bracket for side/top venting
- Overall length 350mm - Rectangular section 42mm x W150mm



SKU	Model No.	Description	Carton Qty	Barcode	S.S.P
	DV4A	DRYER DIVERTER ASSEMBLY	6	9317468671552	29.00

Deflect-o dryer intern lint trap

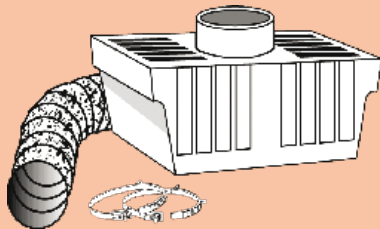

Contents & Features...

Intended for indoor use where external venting is impractical. Fits directly on to dryers with a rear spigot-type outlet. This kit is a uniquely designed water bath trap where the fine lint that is missed by the dryer filter is collected on the water surface.

Simply fill to a 50mm depth of water and change when dirty. Suitable for dryers with a 100mm outlet flange or combine with DVS3 or DV4A diverter kits for dryers with flush outlet hole.

- Water bath Lint Trap - with removable lid
- FO4 - 1 Metre SUPurr-FLEX metallic ducting
- CB34 - Plastic ratchet type clamps (x2)



SKU	Model No.	Description	Carton Qty	Barcode	S.S.P
	LTF	DRYER INTERN LINT TRAP C/W DUCT	6	079916501000	49.00

Deflect-o dryer lint trap

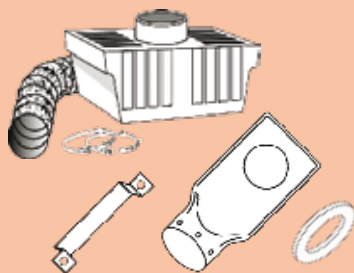

Contents & Features...

Complete with a rear diverter pipe for dryers with a flush, 100mm round outlet hole, this system is intended for indoor use where external venting is impractical.

It is a uniquely designed water bath trap where the fine lint that is missed by the dryer filter is collected on the water surface.

Simply fill to a 50mm depth of water and change when dirty.

- Water bath Lint Trap with removable lid
- FO4 - 1 Metre SUPurr-FLEX metallic ducting
- CB34 - Plastic ratchet type clamps (x2)
- DV4A - Dryer Diverter kit



SKU	Model No.	Description	Carton Qty	Barcode	S.S.P
	LTKA	DRYER LINT TRAP KIT ASSEMBLY	6	9317468671859	78.00

Deflect-o dryer back adaptor kit

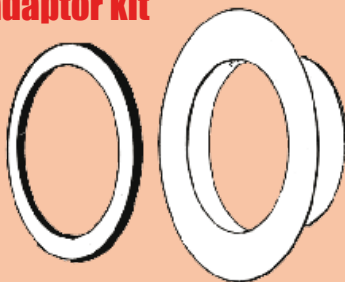

Contents & Features...

Suited for dryers with a round, 100mm Ø outlet, this rear flange kit adheres to the back of the machine using the double sided adhesive gasket ring. This kit allows for the attachment of various External venting options - Refer next page.

Made from galvanised steel for protection against corrosion. Gasket is made from a fire resistant foam.

- GR4 - Double sided, self adhesive Gasket Ring
- DB4 - Galvanised metal flange adaptor 100mm Ø



SKU	Model No.	Description	Carton Qty	Barcode	S.S.P
	DB4K	DRYER BACK ADAPTOR KIT 100mm	6	9317468605014	16.00

Deflect-o Dryer Through wall kit

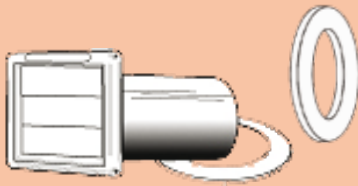

Contents & Features...

This is a 100mm venting system designed to securely vent dryers backed directly against an external wall. Includes a 15mm Foam dust seal that fits around the dryer's outlet .

Suited best for base mounted Dryers ie... Floor or shelf.

Unlike the DVS - Dryer Venting Systems, this kit doesn't allow for hole inaccuracy - the dryer must be aligned exactly in order to connect to the outlet.

- HSR4W - Wall Vent - plastic, gravity louvred
- DP411S - 100mm x 280mm aluminium Clip-Seam Pipe
- IC4 - Internal wall Collar
- FS4 - 15mm thick Foam dust seal



SKU	Model No.	Description	Outlet	Carton Qty	Barcode	S.S.P
	SVHCW4F	DRYER WALL VENT PIPE KIT & SEAL	WALL	6	079916500010	29.00

Deflect-o Universal Clothes dryer Exhaust system - Wall

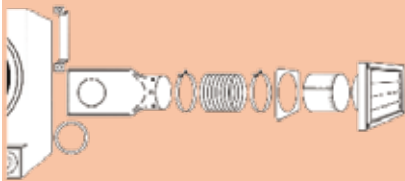

Contents & Features...

Designed to rear vent a dryer through an outside wall via a max. 2.4M of SUPurr-FLEX®. Includes a rectangular to round diverter that fits under a standard wall mounting bracket for side or top venting.

Centre of the dryer's outlet must be within 160mm of the dryer's edge.

- HSR4W - Gravity louvre wall vent
- DP411S - 100mm x 280mm aluminium Clip-Seam Pipe
- IC4 - Internal wall Collar
- CB34 - Plastic ratchet type clamps (x2)
- FO408B - 2.4M SUPurr-FLEX metallic ducting
- DV4A - Rear diverter kit

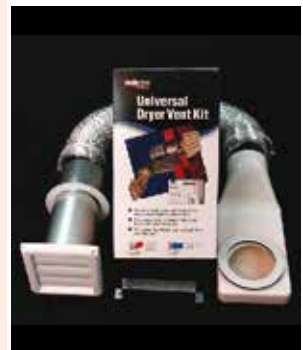

SKU	Model No.	Description	Outlet	Carton Qty	Barcode	S.S.P
	DK4W	DRYER VENT KIT C/W DUCT	WALL	6	9317468500203	78.00

Deflect-o Universal Clothes dryer Exhaust system- Eave



Contents & Features...

Designed to rear vent a dryer up through the ceiling and out through the Eave via up to 4.8M of SUPurr-FLEX®. Includes a rectangular to round diverter that fits under a standard wall mounting bracket for side or top venting. Centre of the dryer's outlet must be within 160mm of the dryer's edge.

- EVE - Under-Eave vent
- DVSA - 100mm Flexible duct adaptor
- DVSWP - Low profile wall plate
- CB34 - Plastic ratchet type clamps (x2)
- FO408B x2 - 2.4M SUPurr-FLEX metallic ducting
- DV4A - Rear diverter kit



SKU	Model No.	Description	Outlet	Carton Qty	Barcode	S.S.P
	DK4E	DRYER VENT KIT C/W DUCT	EAVE	6	9317468500227	98.00

Deflect-o Universal Clothes Dryer Exhaust system - Roof

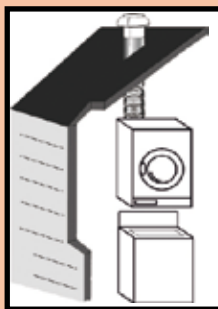

Contents & Features...

Designed to rear vent a dryer up through the ceiling and out through the roof via up to 4.8M of SUPurr-FLEX®. Includes a rectangular to round diverter that fits under a standard wall mounting bracket for side or top venting. Centre of the dryer's outlet must be within 160mm of the dryer's edge. Roof specific flashing sold separately.

- RMC4 - 100mm Roof mushroom cowl
- DVSA - 100mm Flexible duct adaptor
- DVSWP - Low profile wall plate
- CB34 - Plastic ratchet type clamps (x2)
- FO408B x2 - 2.4M SUPurr-FLEX metallic ducting
- DV4A - Rear diverter kit
- GSPS042430 - 30g Galvanised 610mm clip seam piping
- Bracing strap, rivets & drill bit for installation



SKU	Model No.	Description	Outlet	Carton Qty	Barcode	S.S.P
	DK4R	DRYER VENT KIT C/W DUCT	ROOF	6	9317468500234	118.00

DAIW In-Wall Skinny Duct System

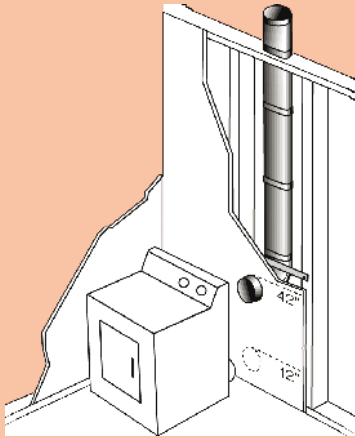

Contents & Features...

This "Skinny Duct" system is designed to be installed inside the wall cavity of new constructions or renovations.

The oval duct fits between wall studs as a permanent venting duct that finishes as a 100mm Ø round pipe for the continuation to an external wall, eave or roof venting option.

- 90°x 100mm Ø Inlet bend to oval duct
- 3 x 800mm Oval piping lengths
- 1 x 300mm Oval piping to 100mm vertical round outlet
- Stud to stud bracing strap
- Full aluminium construction
- Fits between 75mm studs
- Maximum length up to 2.7 Metres
- Continue with fire rated, flexible ducting and external vent



SKU	Model No.	Description	Barcode	S.S.P
	DAIW	DEFLECTO DRYER VENT"SKINNY" 2700mm IN WALL	079916200415	95.00

DAF2 Skinny Duct System

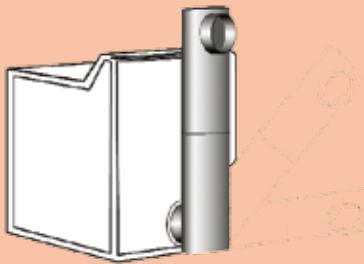

Contents & Features...

This system is designed to fit between the dryer and the wall.

The oval shape of the "Skinny Duct" reduces the protrusion of the dryer within the laundry room. Made from aluminium, it will resist the threat of corrosion and fire.

Telescopic assembly for easy length adjustment.

- 2 piece Oval piping with 100mm Ø horizontal inlet & outlets
- Adjustable length 680-1220mm
- Full aluminium construction
- Offers 360° installation option
- Continue through an outside wall with DVS1 kit.

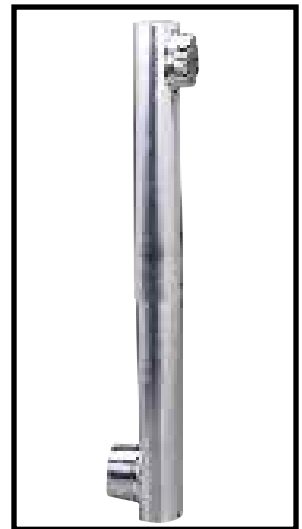

SKU	Model No.	Description	Barcode	S.S.P
	DAF2	DEFLECTO DRYER VENT"SKINNY" 1200mm HORIZ.	079916200392	92.00

DAF3 Skinny Duct System

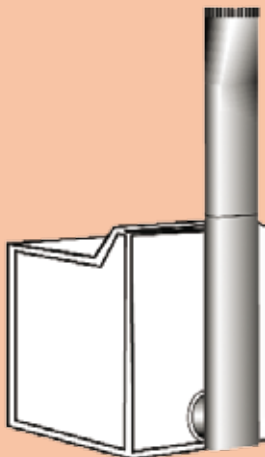

Contents & Features...

This system is designed to fit between the dryer and the wall.

The oval shape of the "Skinny Duct" reduces the protrusion of the dryer within the laundry room. Made from aluminium, it will resist the threat of corrosion and fire.

Telescopic assembly for easy length adjustment.

- 1 piece Oval piping with 100mm Ø horizontal inlet
- 1 piece Oval piping to 100mm Ø vertical round outlet
- Adjustable length 680-1220mm
- Full aluminium construction
- Offers 360° installation option
- Continue with fire rated, flexible ducting and external vent

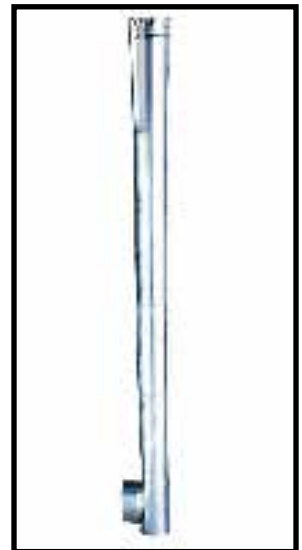

SKU	Model No.	Description	Barcode	S.S.P
	DAF3	DEFLECTO DRYER VENT"SKINNY" 1200mm VERT.	079916200446	92.00

Get the heat without the price tag. Move air around the home for less than operatubg cost of a portable fan heater.

The kits efficiently distribute heated air from a source room to other designated areas within the home requiring similar comfort levels.

It's low operation costs overcome the expenses of installing and running separate appliances for individual rooms.

Kits come supplied with fire-rated Rt 0.6 ducting that complies with AS/NZS 4839.1 Standards. The in-line fan shuts off in the event of an electrical fault meaning you can safely run the system whether you're in the home or not.

HTK1 - 1 to 1 Room

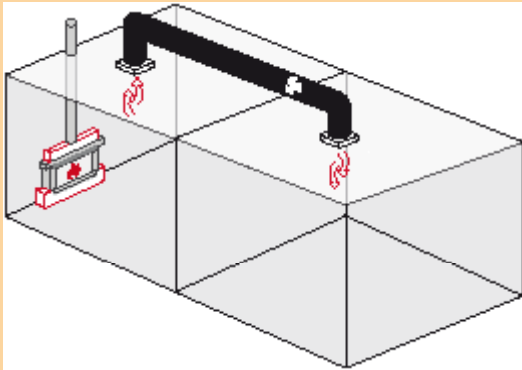

Contents

- IF150 - 150mm Inline Fan
- TFG6 - 150mm Ceiling Diffuser
- DJ150 - 150mm DownJet Ceiling outlet
- D603M - Rt.06 Insulated Ducting 150mm x3M
- D606M - Rt.06 Insulated Ducting 150mm x 6M
- MC6 - 150mm Metal worm drive clamps (x4)

Model No.	Description	Barcode	S.S.P
HTK1	ONE ROOM TO ONE ROOM KIT	9317468919128	399.00

HTK2 - 1 to 2 Rooms

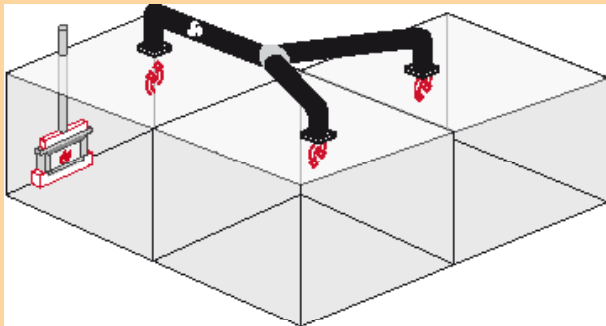

Contents

- IF150 - 150mm Inline Fan
- TFG6 - 150mm Ceiling Diffuser
- DJ150 - 150mm DownJet Ceiling Outlet
- D603M - Rt.06 Insulated Ducting 150mm x 3M
- D606M - Rt.06 Insulated Ducting 150mm x 6M (x2)
- D666-I - Insulated Branch Take Off 150mmx150x150
- MC6 - 150mm Metal Worm Drive Clamps (x8)

Model No.	Description	Barcode	S.S.P
HTK2	ONE ROOM TO TWO ROOMS KIT	9317468919135	499.00

HTK3 - 1 to 3 Rooms

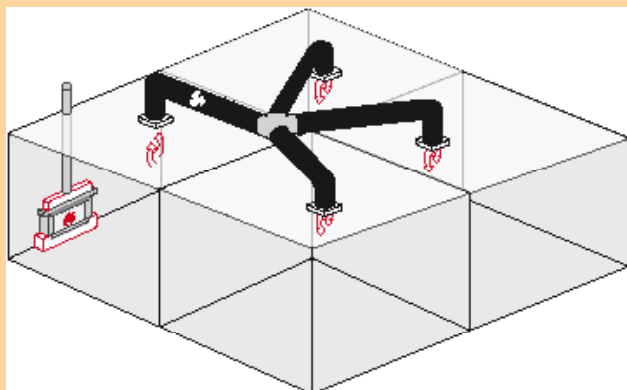

Contents

- IF200 - 200mm Inline Fan
- TFG8 - 200mm Ceiling Diffuser
- DJ150 - 150mm DownJet ceiling outlet (x3)
- D806M - Rt.06 Insulated Ducting 200mm x 6M
- D606M - Rt.06 Insulated Ducting 150mm x 6M (x2)
- D666-I - Insulated Branch Take off 150mmx150x150
- D866-I - Insulated Branch Take Off 200mmx150x150
- MC6 - 150mm Worm Drive Clamp (x8)
- MC8 - 200mm Worm Drive Clamp (x4)

Model No.	Description	Barcode	S.S.P
HTK3	ONE ROOM TO THREE ROOMS KIT	9317468932745	649.00

Air Transfer Kits

Air transfer kits using uninsulated ducting for air transfer from one to one room or one to two rooms.

Contents

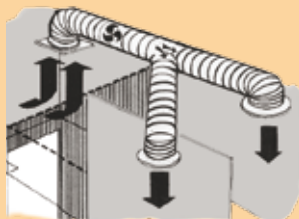

AMK1:

TFG6 - 150mm Inverted cone style ceiling inlet
DJ150 - 150mm DownJet ceiling outlet
FO603M - Supurr Flex ducting 150mm x 11.2M
MC6 - 150mm Metal worm drive clamps (x4)
IF150 - 150mm Inline fan

AMK2:

TFG6 - 150mm Inverted cone style ceiling inlet
DJ150 - 150mm DownJet ceiling outlet (x2)
FO603M - Supurr Flex ducting 150mm x 15.2M
MC6 - 150mm Metal worm drive clamps (x8)
IF150 - 150mm Inline fan
DY666- Y branch Branch Take off

SKU	Model No.	Description	Distance	Barcode	S.S.P
	AMK1	ONE ROOM TO ONE ROOM KIT	UP TO 9 METRES	9317468931618	340.00
	AMK2	ONE ROOM TO TWO ROOMS KIT	UP TO 9 METRES	9317468931625	420.00

Bathroom Ventilation Kits

Internal to External Venting kits - designed to expel the likes of unwanted odours, moisture, smoke and vapours outside improving the health of home occupants and prevents damage to internal fixtures and structures, reducing expensive maintenance costs.

For rooms up to 30 Sq. metres.

Contents

Room to Eave

LR150E:

TFG6 - 150mm Inverted cone style ceiling inlet
FUL0625 - 150mm x 7.6M Supurr Flex ducting
EVE - Under Eave Vent
MC6 - 150mm Metal worm drive clamps (x4)
IF150 - 150mm Inline fan

LR150ESS:

CSSS150 - 150mm Ceiling Diffuser Stainless Steel
FUL0625 - 150mm x 7.6M Supurr Flex ducting
EVSS150 - 150mm Stainless Steel Under Eave Vent
MC6 - 150mm Metal worm drive clamps (x4)
IF150 - 150mm Inline fan

Room to Wall

LR150W:

TFG6 - 150mm Inverted cone style ceiling inlet
FUL0625 - 150mm x 7.6M Supurr Flex ducting
HS6W - 150mm Gravity Wall Vent
MC6 - 150mm Metal worm drive clamps (x4)
IF150 - 150mm Inline fan

LR150WSS:

TFG6 - 150mm Inverted cone style ceiling inlet
FUL0625 - 150mm x 7.6M Supurr Flex ducting
GVSS150 - 150mm Stainless Steel Gravity Wall Vent
MC6 - 150mm Metal worm drive clamps (x4)
IF150 - 150mm Inline fan

SKU	Model No.	Description	Outlet	Barcode	S.S.P
	LR150E	ROOM TO EAVE	PLASTIC	9317468671897	275.00
	LR150ESS	ROOM TO EAVE	STAINLESS STEEL	9317468919531	325.00
	LR150W	ROOM TO WALL	PLASTIC	9317468671903	275.00
	LR150WSS	ROOM TO WALL	STAINLESS STEEL	9317468919548	325.00

Air and Heat transfer kit 150mm inline fan

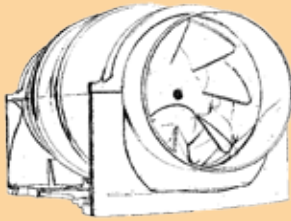

Features...

This fan is used in both heat and air transfer kits and provides for efficient and continuous use in transferring air.

It has two speeds: High speed (2400 rpm 140 L /second) and Low Speed (1900 rpm 90 L /second).

For peace of mind the fan is fitted with a one shot thermal fuse, which switches off in the event of a fault condition. It comes with a 12 month warranty from installation and an 18 month warranty from shipping.

If applicable, the fans can be used with a fan controller switch to allow for variable speed control.



SKU	Model No.	Description	Duct Diameter	Carton Qty	Barcode	S.S.P
	IF150	IN-LINE FAN 150mm	150mm	4	9317468919210	210.00
	IF200	IN-LINE FAN 200mm	200mm	4	9317468932974	295.00

Deflect-o Ceiling Diffuser - Outlets



Features...

The DownJet Ceiling Diffuser evenly disperses air to a chosen area.

Simple to install, it comes with spring loaded attachment arms that lock and secure the vent in place.

Adjustable closure by pushing in and turning the central control knob to activate the internal butterfly damper.



SKU	Model No.	Description	Outer Diameter	Diameter	Carton Qty	Barcode	S.S.P
	DJ150	DOWNJET OUTLET	240mm	150mm	6	9317468681100	33.00
	DJ200	DOWNJET OUTLET	290mm	200mm	6	9317468681117	44.00
	DJ250	DOWNJET OUTLET	340mm	250mm	6	9317468681124	79.00

Insulated Duct



Features...

Silver/black core ducting surrounded by white polyester insulation.

Supplied in a strong, silver foil outer sleeve to help minimise the effects of external conditions on internal duct temperatures.



SKU	Model No.	Description	Diameter	Length	Barcode	S.S.P
	D603M	INSULATED DUCT	150mm	3M	9317468606035	27.00
	D606M	INSULATED DUCT	150mm	6M	9317468606066	51.00

SUPURR-FLEX® Metallic Duct



Features...

Ideally suited for straight venting applications this range of multi-layered, metallic duct offers superior temperature ratings and flame resistant protection.



SKU	Model No.	Description	Diameter	Length	Pack	Carton Qty	Barcode	S.S.P
	FO603M	SUPURR-FLEX	150mm	3.6M	Retail	6	9317468656030	32.00
	FUL0625	SUPURR-FLEX	150mm	7.6M	Retail	6	079916435039	62.00

Deflect-o Ceiling Diffuser - Inlets



Features...

Commonly used for air intake, the design of these Ceiling Diffusers accepts air from surrounding surfaces and not directly below. This makes it ideal for heat, smoke and vapour extraction / transfer.

Adjustable closure by simply screwing the inverted cone centre.

Easy to install and remove for cleaning.



SKU	Model No.	Description	Outer Diameter	Diameter	Carton Qty	Barcode	S.S.P
	TFG6	CEILING DIFFUSER/INTAKE	200mm	150mm	6	079916934216	26.00
	CD200	CEILING DIFFUSER/INTAKE	320mm	200mm	6	9317468671736	44.00

Polycarbonate Ducted Heating Floor Vents

Features

The Deflect-o® range of polycarbonate floor vents are available in 20 designer colours shown in the swatch below.

- Australian made
- Maintenance and Rust free
- Dishwasher safe
- 5 Year replacement warranty



SKU	Model No.	Description	Colour	Size	Carton Qty	Barcode	S.S.P
	D201	POLY.FLOOR VENT	LIGHT BEIGE	300 x 100mm	10	9317468002011	19.50
	D202	POLY.FLOOR VENT	GREY	300 x 100mm	10	9317468002028	19.50
	D203	POLY.FLOOR VENT	PINK	300 x 100mm	10	9317468002035	19.50
	D204	POLY.FLOOR VENT	WHITE	300 x 100mm	10	9317468002042	19.50
	D205	POLY.FLOOR VENT	NEW GREEN	300 x 100mm	10	9317468002059	19.50
	D206	POLY.FLOOR VENT	CREAM	300 x 100mm	10	9317468002066	19.50
	D207	POLY.FLOOR VENT	SLATE	300 x 100mm	10	9317468002073	19.50
	D208	POLY.FLOOR VENT	COFFEE	300 x 100mm	10	9317468002080	19.50
	D209	POLY.FLOOR VENT	CHOCOLATE	300 x 100mm	10	9317468002097	19.50
	D210	POLY.FLOOR VENT	MUSHROOM	300 x 100mm	10	9317468002103	19.50
	D211	POLY.FLOOR VENT	BROWN	300 x 100mm	10	9317468002110	19.50
	D212	POLY.FLOOR VENT	TAN	300 x 100mm	10	9317468002127	19.50
	D213	POLY.FLOOR VENT	DARK BEIGE	300 x 100mm	10	9317468002134	19.50
	D214	POLY.FLOOR VENT	PEACH	300 x 100mm	10	9317468002141	19.50
	D215	POLY.FLOOR VENT	BLUE	300 x 100mm	10	9317468002158	19.50
	D216	POLY.FLOOR VENT	BALTIC PINE	300 x 100mm	10	9317468002165	19.50
	D217	POLY.FLOOR VENT	CARAMEL	300 x 100mm	10	9317468002172	19.50
	D218	POLY.FLOOR VENT	DESERT SAND	300 x 100mm	10	9317468002189	19.50
	D219	POLY.FLOOR VENT	BRUNSWICK GREEN	300 x 100mm	10	9317468002196	19.50
	D220	POLY.FLOOR VENT	STEEL BLUE	300 x 100mm	10	9317468002202	19.50
	D221	POLY.FLOOR VENT	LIGHT BEIGE	350 x 150mm	10	9317468002219	51.00
	D222	POLY.FLOOR VENT	GREY	350 x 150mm	10	9317468002226	51.00
	D223	POLY.FLOOR VENT	PINK	350 x 150mm	10	9317468002233	51.00
	D224	POLY.FLOOR VENT	WHITE	350 x 150mm	10	9317468002240	51.00
	D225	POLY.FLOOR VENT	NEW GREEN	350 x 150mm	10	9317468002257	51.00
	D226	POLY.FLOOR VENT	CREAM	350 x 150mm	10	9317468002264	51.00
	D227	POLY.FLOOR VENT	SLATE	350 x 150mm	10	9317468002271	51.00
	D228	POLY.FLOOR VENT	COFFEE	350 x 150mm	10	9317468002288	51.00
	D229	POLY.FLOOR VENT	CHOCOLATE	350 x 150mm	10	9317468002295	51.00
	D230	POLY.FLOOR VENT	MUSHROOM	350 x 150mm	10	9317468002301	51.00
	D231	POLY.FLOOR VENT	BROWN	350 x 150mm	10	9317468002318	51.00
	D232	POLY.FLOOR VENT	TAN	350 x 150mm	10	9317468002325	51.00
	D233	POLY.FLOOR VENT	DARK BEIGE	350 x 150mm	10	9317468002332	51.00
	D234	POLY.FLOOR VENT	PEACH	350 x 150mm	10	9317468002349	51.00
	D235	POLY.FLOOR VENT	BLUE	350 x 150mm	10	9317468002356	51.00
	D236	POLY.FLOOR VENT	BALTIC PINE	350 x 150mm	10	9317468002363	51.00
	D237	POLY.FLOOR VENT	CARAMEL	350 x 150mm	10	9317468102370	51.00
	D238	POLY.FLOOR VENT	DESERT SAND	350 x 150mm	10	9317468102387	51.00
	D239	POLY.FLOOR VENT	BRUNSWICK GREEN	350 x 150mm	10	9317468102394	51.00
	D240	POLY.FLOOR VENT	STEEL BLUE	350 x 150mm	10	9317468102400	51.00

ABS Plastic Vents

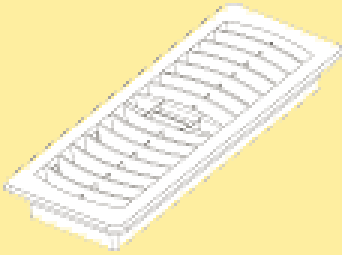

Features...

The Deflect-o® range of ABS plastic floor vents feature the latest design with a sleek modern look, rounded corners and wider vent blades. These floor vents have a smooth, fully closing damper operation with flush button control mechanism.

- Super high strength - compared to polycarbonate vents
- Maintenance and rust free
- Dishwasher safe
- 12 Attractive designer colours
- 5 Year replacement warranty

*Hint - To deflect air across the floor use Model 50 or 99 Air Deflectors

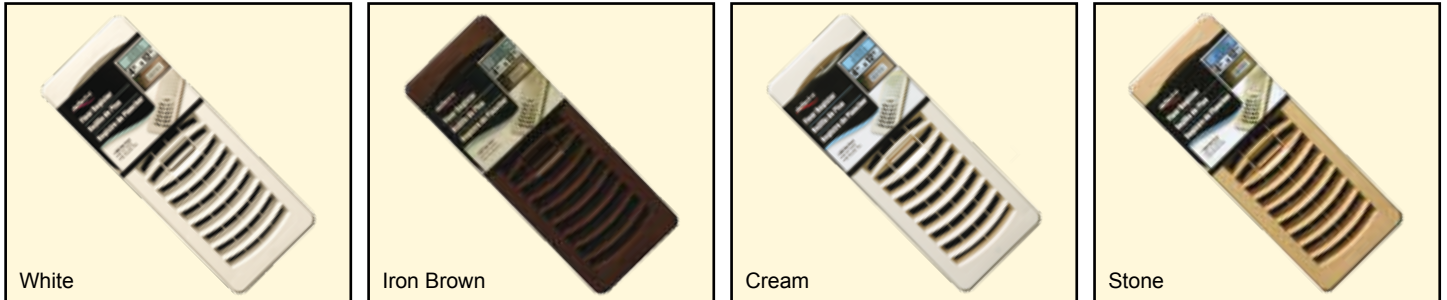

White

Iron Brown

Cream

Stone



Earth

Beige

Gum Green

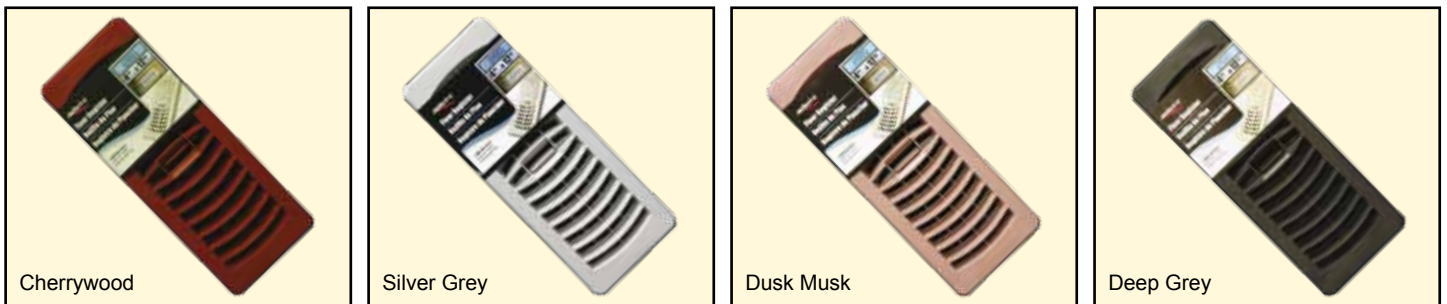

Cherrywood

Silver Grey

Dusk Musk

Deep Grey

SKU	Model No.	Description	Colour	Hole Size	Carton Qty	Barcode	S.S.P
	RF41203	FLOOR VENT	WHITE	300 x 100mm	10	079916201733	9.90
	RF41213	FLOOR VENT	IRON BROWN	300 x 100mm	10	079916212135	9.90
	RF41217	FLOOR VENT	CREAM	300 x 100mm	10	079916212173	9.90
	RF41218	FLOOR VENT	STONE	300 x 100mm	10	079916212180	9.90
	RF41226	FLOOR VENT	EARTH	300 x 100mm	10	079916212265	9.90
	RF41228	FLOOR VENT	BEIGE	300 x 100mm	10	079916201771	9.90
	RF41239	FLOOR VENT	HONEYWOOD	300 x 100mm	10	079916212395	9.90
	RF41244	FLOOR VENT	GUM GREEN	300 x 100mm	10	079916212449	9.90
	RF41249	FLOOR VENT	CHERRYWOOD	300 x 100mm	10	079916212494	9.90
	RF41253	FLOOR VENT	SILVER GREY	300 x 100mm	10	079916212531	9.90
	RF41256	FLOOR VENT	DUSK MUSK	300 x 100mm	10	079916212562	9.90
	RF41259	FLOOR VENT	DEEP GREY	300 x 100mm	10	079916212593	9.90

Deflect-o Premium Unbreakable Air Deflector

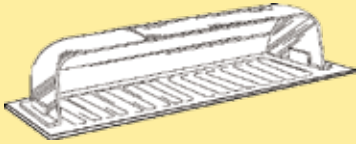

Features...

Increase heating efficiency and save money by directing air flow from floor vents along the floor rather than up walls or behind curtains and furniture.

- Adjustable 250mm - 360mm x 100mm Deep
- Clear polycarbonate plastic
- Unbreakable under normal use



SKU	Model No.	Description	Size	Carton Qty	Barcode	S.S.P
	50	PREMIUM AIR DEFLECTOR UNBREAK.	360 x 100 x 100mm	24	079916000503	11.90

Deflect-o Large Floor or wall use

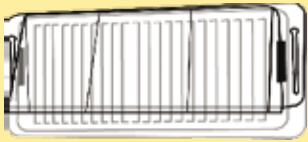

Features...

Redirects air flow up, down or along the floor for additional, comfort.

- Adjustable from 250mm wide to 400mm wide
- Suitable for 150mm wide vents
- Supplied with strong magnets
- Can also be screw mounted for wall use



SKU	Model No.	Description	Size	Carton Qty	Barcode	S.S.P
	51	LARGE AIR DEFLECTOR SUIT	450 x 150 x 100mm	12	079916000510	19.80

Deflect-o Standard Air Deflector

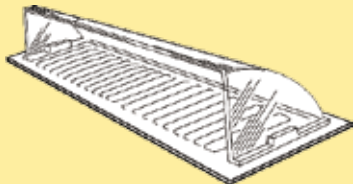

Features...

Increase heating efficiency and save money by directing air flow from floor vents along the floor rather than up walls or behind curtains and furniture.

- Supplied with strong metal magnets & Velcro®
- Standard quality - for Unbreakable see Model 50 above

* Model 67 can be used as an extension sleeve for models 99 & 50.



SKU	Model No.	Description	Size	Carton Qty	Barcode	S.S.P
	99	DUCTED HEAT AIR DEFLECTOR STD.	360 x 100 x 100mm	48	079916000992	9.90
	67	EXTENSION SLEEVE	250mm Long	12	079916000671	6.00

Deflect-o Metal & Wooden Floor Vents

Features...

The Deflect-o® range of Metal floor vents are contemporary, stylish and modern. With different textures, colours and designs to choose from they can be made the feature of any room.

- Attractive designs
- Adjustable dampner
- A variety of choice in colour and design
- Wooden and metal options
- Has standard 300 x 100mm rear flange dimensions



SKU	Model NO.	Description	Colour	Hole Size	Carton Qty	Design	Barcode	S.S.P
	DMRCHROME	FLOOR VENT	CHROME	300 x 100mm	10	STANDARD	9317468002516	19.00
	MVANTBRAS	FLOOR VENT	ANTIQU BRASS	300 x 100mm	10	STANDARD	9317468002769	19.00
	MVNICK	FLOOR VENT	NICKEL	300 x 100mm	10	STANDARD	9317468002776	19.00
	DMRBRASS	FLOOR VENT	BRASS	300 x 100mm	10	STANDARD	9317468002493	19.00
	MVCHAR	FLOOR VENT	CHARCOAL	300 x 100mm	10	STANDARD	9317468002738	14.00
	MVWHITE	FLOOR VENT	WHITE	300 x 100mm	10	STANDARD	9317468002707	14.00
	MVCHOC	FLOOR VENT	CHOCOLATE	300 x 100mm	10	STANDARD	9317468002752	14.00
	MVGREY	FLOOR VENT	GREY	300 x 100mm	10	STANDARD	9317468002721	14.00
	MVBROWN	FLOOR VENT	BROWN	300 x 100mm	10	STANDARD	9317468002745	14.00
	MVLTBEIGE	FLOOR VENT	LIGHT BEIGE	300 x 100mm	10	STANDARD	9317468002714	14.00
	DMR1228	FLOOR VENT	BEIGE	300 x 100mm	10	STANDARD	9317468002424	14.00
	DMR1217	FLOOR VENT	CREAM	300 x 100mm	10	STANDARD	9317468002523	14.00
	MVICNICK	FLOOR VENT	NICKEL	300 x 100mm	10	VICTORIAN	9317468002837	19.00
	MVICWHITE	FLOOR VENT	WHITE	300 x 100mm	10	VICTORIAN	9317468002820	19.00
	MVICPBRASS	FLOOR VENT	POLISHED BRASS	300 x 100mm	10	VICTORIAN	9317468002783	19.00
	MVICCHROME	FLOOR VENT	CHROME	300 x 100mm	10	VICTORIAN	9317468002813	19.00
	MVICANTBRASS	FLOOR VENT	ANTIQU BRASS	300 x 100mm	10	VICTORIAN	9317468002790	19.00
	MVICBLACK	FLOOR VENT	BLACK	300 x 100mm	10	VICTORIAN	9317468002806	19.00
	WOODPOLOAK	FLOOR VENT	POLISHED OAK	300 x 100mm	10	STANDARD	9317468002844	21.00
	WOODUNFOAK	FLOOR VENT	UNFINISHED OAK	300 x 100mm	10	STANDARD	9317468002851	21.00

Deflect-o floor Duct Extension Kit

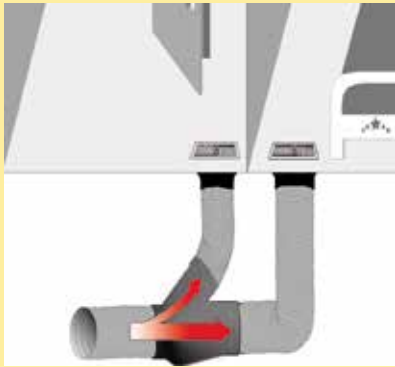

Contents & Features...

The floor duct extension kit is the ideal solution to extending your ducted heating system. Whether it be adding an additional outlet to an existing room or adding an outlet to a new room, you'll find everything you need, all in one easy to use DIY kit.

- D301 - Plastic floor vent boot 300x100mm
- D606M - Insulated ducting 150mm x 6M
- D886 - Plastic branch take-off 200x200x150mm
- MC6 - Worm drive metal clamps 150mm (x2)
- MC8 - Worm drive metal clamps 150mm (x2)
- Easy to use, DIY kit for adding an additional outlet to your existing 200mm duct system
- Allows for 150mm branch take-off to an additional room/outlet
- Floor vents sold separately, select from our extensive range of 300 x 100 floor vents.

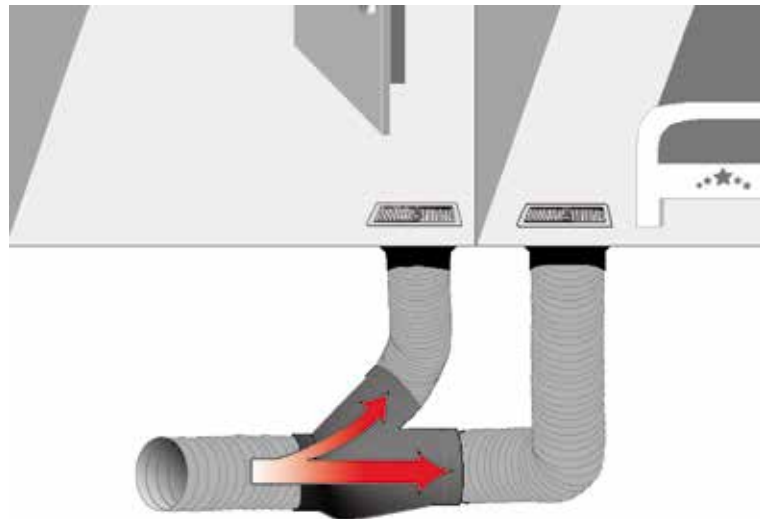

SKU	Model No.	Description	Duct Diameter	Barcode	S.S.P
	FDK150	FLOOR DUCT EXTENSION KIT - 6M	150mm	9317468301503	155.00

Deflect-o plastic floor Vent Boot

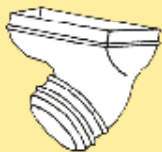

Features...

Made from black, blown moulded plastic with internal pivot damper for adjustable air volume control. Suits metal and plastic Floorvents with below listed dimensions.

- Subfloor or wall mountable



SKU	Model No.	Description	Size	Duct Diameter	Barcode	S.S.P
	D301	FLOOR BOOT	300 x 100mm	150mm	9317468603010	13.00
	D302	FLOOR BOOT	300 x 100mm	200mm	9317468603027	27.00
	D303	FLOOR BOOT	350 x 150mm	200mm	9317468603034	52.00
	D304	FLOOR BOOT	350 x 150mm	250mm	9317468603041	78.00

Y Branch Take-Off



INSULATED

Features...

Made from black, blown moulded plastic these "Y" branches allow for a venting system to be directed to / received from two evenly distributed areas.

- 50/50 Split of airflow



PLAIN

Plain

SKU	Model No.	Description	Size	Barcode	S.S.P
	DY644	"Y" DUCT CONNECTOR	150 x 100 x 100mm	9317468919555	20.00
	DY866	"Y" DUCT CONNECTOR	200 x 150 x 150mm	9317468681155	20.00
	DY1088	"Y" DUCT CONNECTOR	250 x 200 x 200mm	9317468110884	36.00

Insulated

SKU	Model No.	Description	Size	Barcode	S.S.P
	DY644-I	"Y" DUCT CONNECTOR INSULATED	150 x 100 x 100mm	9317468931564	32.00
	DY866-I	"Y" DUCT CONNECTOR INSULATED	200 x 150 x 150mm	9317468931571	52.00
	DY1088-I	"Y" DUCT CONNECTOR INSULATED	250 x 200 x 200mm	9317468931519	82.00

Single Branch Take-Off



INSULATED

Features...

Made from black, blown moulded plastic these Branch Take-Offs allow for a venting system to be directed to / received from two areas. The 45 degree angle Take-Off will offer a lesser or a more subtle volume of air to a secondary room as majority of airflow will be sent to the in-line outlet.



PLAIN

Plain

SKU	Model No.	Description	Size	Barcode	S.S.P
	D866	BRANCH TAKE-OFF	200 x 150 x 150mm	9317468608664	24.00
	D886	BRANCH TAKE OFF	200 x 200 x 150mm	9317468608862	29.00
	D888	BRANCH TAKE OFF	200 x 200 x 200mm	9317468608886	29.00
	D1086	BRANCH TAKE OFF	250 x 200 x 150mm	9317468931588	39.00
	D1088	BRANCH TAKE OFF	250 x 200 x 200mm	9317468610889	39.00
	D10108	BRANCH TAKE OFF	250 x 250 x 200mm	9317468101073	41.00
	D12108	BRANCH TAKE OFF	300 x 250 x 200mm	9317468931595	45.00
	D121010	BRANCH TAKE OFF	300 x 250 x 250mm	9317468121019	56.00

Insulated

SKU	Model No.	Description	Size	Barcode	S.S.P
	D666-I	BRANCH TAKE OFF INSULATED	150 x 150 x 150mm	9317468931960	42.30
	D866-I	BRANCH TAKE OFF INSULATED	200 x 150 x 150mm	9317468931601	47.00
	D886-I	BRANCH TAKE OFF INSULATED	200 x 200 x 150mm	9317468919623	71.00
	D888-I	BRANCH TAKE OFF INSULATED	200 x 200 x 200mm	9317468919104	71.00
	D1086-I	BRANCH TAKE OFF INSULATED	250 x 200 x 150mm	9317468919630	71.00
	D1088-I	BRANCH TAKE OFF INSULATED	250 x 200 x 200mm	9317468919647	71.00
	D10108-I	BRANCH TAKE OFF INSULATED	250 x 250 x 200mm	9317468919654	75.00
	D12108-I	BRANCH TAKE OFF INSULATED	300 x 250 x 200mm	9317468919661	81.00
	D121010-I	BRANCH TAKE OFF INSULATED	300 x 250 x 250mm	9317468919678	93.00

Vent introduction...

There are varieties of vents in the following section that may be applied to many different applications and requirements.

JPM would like to highlight additional features of some of the vents to assist in choosing the correct vent for your needs. Should you ever require further help - don't hesitate to contact our Head Office 1800 859 956.

Deflect-o Plastic 'H' series vents

Australia can produce extreme weather conditions and this is why all Deflect-o "H" series vents are manufactured using the most resilient plastic compounds to ensure the integrity of the vent lasts and functions for many years to come. Our vents are designed not to warp, become brittle or yellow in colour under harsh conditions - Be sure to consider this when comparing to cheaper alternatives.



Gravity Louvered vents

One way exhaust vent that offers protection against backdrafts and vermin entry. No flyscreen required as this may restrict airflow or require regular maintenance.



Fixed Grill vents

A flyscreened Inlet or Outlet vent with removable front grill for easy-clean maintenance. Use in low air-volume capacity or long +5 Metre Rangehood venting applications. Mesh is not recommended for Clothes Dryers.



Fixed Louvered vents

A 3 tier, bull-nosed style vent that offers minimal airflow restriction for Inlet or Outlet ventilation. Offers 12mm x 12mm square mesh to eliminate bird entry. May be applied as a sub-floor vent.

Kensington Stainless Steel vents

All 100mm, 125mm & 150mm vents in this range have an optional cinder mesh cover available that conforms to Building Code P2.3.4 "medium to high risk" bushfire mesh aperture - making them a safer and more attractive venting option to plastic.

Manufactured in quality 304 Grade - 18/10 Stainless Steel



Gravity vents

4 x Gravity flaps that close when not in use to protect against backdrafts and vermin entry. Also available in 200mm



Hood vents

Internal gravity flap that closes when not in use to protect against backdrafts and vermin entry. Ideal for high wind areas.



Eave vents

Flush mount internal or external wall, ceiling or under-eave vent option with strong front screen to prevent vermin entry.



Dome vents

Fixed louvred vent protected by a stylish round moulded hood. May be used as an inlet or exhaust vent.

Deflect-o Gravity Louvred

Features...



The gravity louvred vent - commonly known as a flap vent - is designed to allow air to be vented into the atmosphere, while stopping cold air and pests entering the system when not in use.

The louvres are specially manufactured in a curved shape to assist in keeping the vent closed if effected by wind or drafts. Modern, rounded edges with mounting holes in each corner.

- UV Resistant
- Calcium filled polypropylene plastic
- 25mm Deep rear flange for ducting attachment

*Hint - use with metal worm drive clamp to secure ducting



SKU	Model No.	Description	Ext Size	Duct Diameter	Carton Qty	Pack	Barcode	S.S.P
	HSR4W	GRAVITY LOUVRE	150 x 150mm	100mm	6	Retail	079916500539	15.00
	HS4WJ	GRAVITY LOUVRE	150 x 150mm	100mm	48	Loose	N/A	13.00
	HSR5W	GRAVITY LOUVRE	205 x 205mm	125mm	6	Retail	079916502106	26.00
	HS5W	GRAVITY LOUVRE	205 x 205mm	125mm	12	Loose	N/A	24.00
	HSR6W	GRAVITY LOUVRE	205 x 205mm	150mm	6	Retail	079916500553	26.00
	HS6W	GRAVITY LOUVRE	205 x 205mm	150mm	12	Loose	N/A	23.00
	MV200	GRAVITY LOUVRE	250 x 250mm	200mm	19	Loose	9317468147064	34.00

Deflect-o split rear flange

Features...



The gravity louvre wall vents are for exhaust air flow only. With a split rear flange for attachment of aluminium clip seam pipe these vents are used in the dryer venting kits.

- Calcium filled polypropylene plastic
- UV resistant



SKU	Model No.	Description	Ext Size	Duct Diameter	Pack	Carton Qty	Barcode	S.S.P
	HS4W	GRAVITY LOUVRE	150 x 150mm	100mm	Loose	48	N/A	14.50
	DP411S	Alum pipe for HS4W	280mm	100mm	Loose	24	N/A	6.00

Kensington Gravity Louvred



Features...

Manufactured in quality stainless steel, this gravity louvred vent is designed to allow air to be vented into the atmosphere, while stopping cold air and pests entering the system when not in use.

*Purchase cinder mesh attachment to make fire safe to comply to BAL 12.5 (BUSHFIRE ATTACK LEVEL) Refer to page 30.

- 304 Grade - 18/10 Stainless steel



SKU	Model No.	Description	Ext Size	Duct Diameter	Pack	Carton Qty	Barcode	S.S.P
	GVSS100	GRAVITY LOUVRE	155 x 155mm	100mm	Retail	3	9317468004503	44.00
	GVSS100B	GRAVITY LOUVRE	155 x 155mm	100mm	Loose	72	N/A	42.00
	GVSS125	GRAVITY LOUVRE	180 x 180mm	125mm	Retail	3	9317468004510	54.00
	GVSS125B	GRAVITY LOUVRE	180 x 180mm	125mm	Loose	32	N/A	52.00
	GVSS150	GRAVITY LOUVRE	180 x 180mm	150mm	Retail	3	9317468004527	64.00
	GVSS150B	GRAVITY LOUVRE	180 x 180mm	150mm	Loose	38	N/A	62.00
	GVSS200B	GRAVITY LOUVRE	265 x 265mm	200mm	Loose	16	9317468004534	125.00

Kensington Hood Vent



Features...

Manufactured in quality stainless steel, this hood vent is ideal for snow and heavy rain regions. The internal gravity flap allows air to be vented into the atmosphere, while stopping cold air and pests entering the system when not in use.

*Purchase cinder mesh attachment to make fire safe to comply to BAL 12.5 (BUSHFIRE ATTACK LEVEL) Refer to page 30.

- 304 Grade - 18/10 Stainless steel



SKU	Model No.	Description	Ext Size	Duct Diameter	Pack	Carton Qty	Barcode	S.S.P
	HVSS100	WIDE MOUTH HOOD	155 x 155 x 80mm	100mm	Retail	3	9317468004541	48.00
	HVSS100B	WIDE MOUTH HOOD	155 x 155 x 80mm	100mm	Loose	36	N/A	46.00
	HVSS125	WIDE MOUTH HOOD	180 x 180 x 90mm	125mm	Retail	3	9317468004558	55.00
	HVSS125B	WIDE MOUTH HOOD	180 x 180 x 90mm	125mm	Loose	18	N/A	53.00
	HVSS150	WIDE MOUTH HOOD	180 x 180 x 90mm	150mm	Retail	3	9317468004565	64.00
	HVSS150B	WIDE MOUTH HOOD	180 x 180 x 90mm	150mm	Loose	18	N/A	62.00

Kensington Dome Vent



Features...

Manufactured in quality stainless steel, this dome styled vent is an alternative fixed louvred, Wall vent that is protected by a stylish round hood. May also be used as an inlet vent.

*Purchase cinder mesh attachment to make fire safe to comply to BAL 12.5 (BUSHFIRE ATTACK LEVEL) Refer to page 30.

- 304 Grade - 18/10 Stainless Steel



SKU	Model No.	Description	Ext Size	Duct Diameter	Pack	Carton Qty	Barcode	S.S.P
	DVSS100	DOME VENT	150 x 85mm	100mm	Retail	3	9317468004619	40.00
	DVSS100B	DOME VENT	150 x 85mm	100mm	Loose	48	N/A	38.00
	DVSS125	DOME VENT	185 x 95mm	125mm	Retail	3	9317468004626	46.00
	DVSS125B	DOME VENT	185 x 95mm	125mm	Loose	22	N/A	43.00
	DVSS150	DOME VENT	185 x 95mm	150mm	Retail	3	9317468004633	58.00
	DVSS150B	DOME VENT	185 x 95mm	150mm	Loose	22	N/A	56.00
	DVSS200B	DOME VENT		200mm	Loose	1	N/A	125.00

Kensington Fixed Louvre



Features...

The fixed louvred vents in this range may be used as an outlet, or fresh air intake vent. *Purchase cinder mesh attachment to avoid the entry of pests and make fire safe to comply to BAL 12.5 (BUSHFIRE ATTACK LEVEL) Refer to page 30.

*Cinder mesh not available for 200mm version

- 304 Grade - 19/10 stainless steel



SKU	Model No.	Description	Ext Size	Duct Diameter	Pack	Carton Qty	Barcode	S.S.P
	FLSS100B	OPEN FIXED LOUVRE	150 x 150mm	100mm	Loose	60	9317468001915	44.00
	FLSS125B	OPEN FIXED LOUVRE	175 x 175mm	125mm	Loose	36	9317468001922	57.00
	FLSS150B	OPEN FIXED LOUVRE	175 x 175mm	150mm	Loose	42	9317468001939	65.00
	FLSS200B	OPEN FIXED LOUVRE	260 x 260mm	200mm	Loose	16	9317468001946	125.00

Deflect-o Fixed Louvred



Features...

The fixed louvred vents in this range may be used as an outlet, or fresh air intake vent. The 100mm vent has vertical grills between the louvres, whilst the 125 & 150mm vents have a 12mm mesh on their rear flanges to prevent birds and rodents from entering.

- UV Resistant
- White - Calcium filled polypropylene plastic



SKU	Model No.	Description	Ext Size	Duct Diameter	Pack	Carton Qty	Barcode	S.S.P
	HSM4WR	OPEN FIXED LOUVRE	150 x 150mm	100mm	Retail	6	9317468671941	11.00
	HSM4W	OPEN FIXED LOUVRE	150 x 150mm	100mm	Loose	24	N/A	9.00
	HSM5WR	OPEN FIXED LOUVRE	205 x 205mm	125mm	Retail	6	9317468671958	22.00
	HSM5W	OPEN FIXED LOUVRE	205 x 205mm	125mm	Loose	12	N/A	20.00
	HSM6WR	OPEN FIXED LOUVRE	205 x 205mm	150mm	Retail	6	9317468671965	22.00
	HSM6W	OPEN FIXED LOUVRE	205 x 205mm	150mm	Loose	12	N/A	20.00

Deflecto Fixed Grill Vent



Features...

The grill vents in this range may be used as an outlet, or fresh air intake vent. Use as a wall, ceiling or under eave venting option. Features a removable front grill for easy-clean maintenance of flyscreen.

- UV Resistant
- White - Calcium filled polypropylene plastic
- Removable front grill
- Flyscreen mesh behind grill included



SKU	Model No.	Description	Ext Size	Duct Diameter	Pack	Carton Qty	Barcode	S.S.P
	HGV4	LOW PROFILE FIXED LOUVRE	150 x 150mm	100mm	Retail	6	9317468502146	12.00
	HGV4WJ	LOW PROFILE FIXED LOUVRE	150 x 150mm	100mm	Loose	48	N/A	10.00
	HGV5	LOW PROFILE FIXED LOUVRE	205 x 205mm	125mm	Retail	6	9317468502153	24.00
	HGV5WJ	LOW PROFILE FIXED LOUVRE	205 x 205mm	125mm	Loose	12	N/A	22.00
	HGV6	LOW PROFILE FIXED LOUVRE	205 x 205mm	150mm	Retail	6	9317468502160	24.00
	HGV6WJ	LOW PROFILE FIXED LOUVRE	205 x 205mm	150mm	Loose	12	N/A	22.00

Deflect-o under eave



Features...

Clever by design, this vent offers under-eave venting for diameters up to 125mm. Centre an exhaust pipe/ duct between the 2 internal, backflow control dampers. Exhaust disperses on either side of the arch, opening up the dampers to vent out through side grills. When there is no mechanical air movement, the dampers simply close off to prevent vermin and back draft entry.

- L260mm x W180mm x D60mm
- Diameter use...75 - 125mm
- Calcium filled, UV stabilised plastic
- Ensure the hole cut in the eave is set between the 2 dampers



SKU	Model No.	Description	Duct Diameter	Pack	Carton Qty	Barcode	S.S.P
	EVE	UNDER-EAVE VENT	75-150mm	Retail	6	079916500805	29.00

ATC Grill Vent - Round



Features...

Economy standard fixed louvred vent that may be used for wall or eave venting. Not recommended for rangehood use as they are supplied with flyscreen mesh that can clog and restrict airflow. Ideally used as an internal, intake vent.



SKU	Model No.	Description	Ext Size	Duct Diameter	Pack	Carton Qty	Barcode	S.S.P
	MV100BVS	ROUND VENT	128mm	100mm	Retail	90	9317468147101	4.00
	MV125BVS	ROUND VENT	160mm	125mm	Retail	60	9317468147118	5.00
	MV150BVS	ROUND VENT	200mm	150mm	Retail	24	9317468147125	6.00

Kensington Round Flush - Mesh Vent



Features...

Manufactured in quality stainless steel, this round, flush vent is ideal for under-eave venting. The open mesh face allows it to be also used for wall or ceilings, as an inlet or outlet vent.

*Purchase cinder mesh attachment to make fire safe to comply to BAL 12.5 (BUSHFIRE ATTACK LEVEL) See below.

*Hint - use with metal worm drive clamp to secure ducting



SKU	Model No.	Description	Ext Size	Duct Diameter	Pack	Carton Qty	Barcode	S.S.P
	EVSS100	EAVE VENT	150mm	100mm	Retail	3	9317468004572	36.00
	EVSS100B	EAVE VENT	150mm	100mm	Loose	48	N/A	34.00
	EVSS125	EAVE VENT	185mm	125mm	Retail	3	9317468004589	40.00
	EVSS125B	EAVE VENT	185mm	125mm	Loose	48	N/A	38.00
	EVSS150	EAVE VENT	210mm	150mm	Retail	3	9317468004596	46.00
	EVSS150B	EAVE VENT	210mm	150mm	Loose	24	N/A	44.00
	EVSS200B	EAVE VENT	265mm	200mm	Loose	24	9317468006606	58.00

Deflect-o Roof cap exhaust



Features...

Self-flashing on slate and flat bitumen style roofs. This vent has an internal damper that closes when not in use. Base size is 280mm x 330mm.

Offers 100mm and 125mm connection tail piece for easy duct connection.

- Prevents rain, bird and vermin entry
- Installation by a professional is recommended

*Hint - use metal worm drive clamps to secure ducting

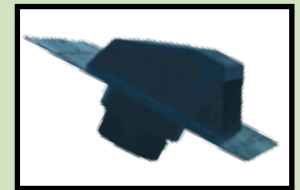

SKU	Model No.	Description	Carton Qty	Barcode	S.S.P
	RCT	DEFLECTO ROOF CAP VENT L/PROFILE 100/125mm	6	079916202105	75.00

Deflect-o Roof Mushroom Cowl



Features...

The unique design of these cowls offers superior protection from rain, back drafts and rodents. Matches with GSPS and PPS coded piping.

- Provides efficient air/ exhaust expulsion
- Aluminium construction

*Purchase cinder mesh attachment to make fire safe to comply to BAL 12.5 (BUSHFIRE ATTACK LEVEL) See below.



SKU	Model No.	Description	Duct Diameter	Pack	Carton Qty	Barcode	S.S.P
	RMC4	MUSHROOM COWL	100mm	Retail	10	9317468612074	35.00
	RMC5	MUSHROOM COWL	125mm	Retail	8	9317468612081	38.00
	RMC6	MUSHROOM COWL	150mm	Retail	8	9317468612098	40.00
	RMC8	MUSHROOM COWL	200mm	Retail	4	9317468612111	69.00

Xbase China Hat Cowl



Features...

Made from galvanised steel they can offer weather protection and air or exhaust expulsion.



SKU	Model No.	Description	Duct Diameter	Pack	Carton Qty	Barcode	S.S.P
	MCH100	CHINA HAT	100mm	Retail	6		TBA
	MCH125	CHINA HAT	125mm	Retail	4		TBA
	MCH150	CHINA HAT	150mm	Retail	4		TBA
	MCH200	CHINA HAT	200mm	Retail	2		TBA

Cinder Mesh insert Round or Rectangular

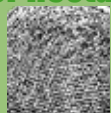

Features...

Made from quality 304 grade stainless steel with less than 2mm apertures these cinder mesh inserts are suitable for all stainless steel and other venting applications to make them suitable for fire rated areas as they comply to bushfire attack code BAL 12.5.

They can also be used around the house to block rodents or pests entering the ventilation system. Available in both rectangular OR round inserts.



SKU	Model No.	Description	Duct Diameter	Pack	Carton Qty	Barcode	S.S.P
	IMA100	INSERT - ROUND	100mm	Retail	20	9317468919173	4.00
	IMA125	INSERT - ROUND	125mm	Retail	20	9317468919180	4.50
	IMA150	INSERT - ROUND	150mm	Retail	20	9317468919197	5.00
	IMA200	INSERT - ROUND	200mm	Retail	20	9317468919203	6.00
	RIMA	INSERT - RECTANGULAR	90 X 700mm	Retail	20	9317468919449	3.40

Euro Style Diffuser - STAINLESS STEEL



Features...

Commonly used for air intake, the design of these ceiling diffusers accepts air from surrounding surfaces and not directly below. This makes it ideal for heat, smoke and vapour extraction/ transfer. For desired airflow control, simply screw the inverted cone centre.

- Adjustable closure
- Easy installation and removal for cleaning



SKU	Model No.	Description	Duct Diameter	Ext. size	Pack	Carton Qty	Barcode	S.S.P
	CDSS100	CEILING DIFFUSER/INTAKE	100mm	150mm	Retail	24	9317468006743	31.00
	CDSS125	CEILING DIFFUSER/INTAKE	125mm	150mm	Retail	24	9317468006750	40.00
	CDSS150	CEILING DIFFUSER/INTAKE	150mm	200mm	Retail	24	9317468006767	49.00
	CDSS200B	CEILING DIFFUSER/INTAKE	200mm	250mm	Loose	12	9317468006774	88.00

Euro Style Diffuser - PLASTIC



Features...

As Above in Plastic.



SKU	Model No.	Description	Duct Diameter	Ext. Size	Pack	Carton Qty	Barcode	S.S.P
	TFG4	CEILING DIFFUSER/INTAKE	100mm	150mm	Retail	6	079916934310	18.50
	TFG6	CEILING DIFFUSER/INTAKE	150mm	200mm	Retail	6	079916934211	26.00

ATC Euro Style Diffuser

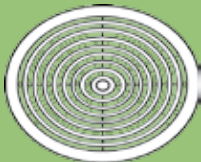

Features...

Commonly used as an outlet vent, the design disperses air evenly away from the centre.

This is an open style vent with a snap off front grill and flyscreen insert.

- White - Plastic
- Easy installation
- Removable front grill for easy cleaning



SKU	Model No.	Description	Duct Diameter	Ext. Size	Pack	Carton Qty	Barcode	S.S.P
	MV100PFS	CEILING DIFFUSER	100mm	145mm	Retail	25	9317468148047	8.00
	MV125PFS	CEILING DIFFUSER	125mm	170mm	Retail	20	9317468148054	9.00
	MV150PFS	CEILING DIFFUSER	150mm	190mm	Retail	15	9317468148061	11.00
	MV200PFS	CEILING DIFFUSER	200mm	245mm	Retail	22	9317468148085	13.00
	MV250PFS	CEILING DIFFUSER	250mm	300mm	Retail	12	9317468148108	25.00

Deflect-o Downjet Diffuser



Features...

This range of downjet ceiling diffusers evenly disperses air to a chosen area. Simple to install, it comes with spring loaded attachment arms that lock and secure the vent in place. For desired airflow control, push in and turn the central control knob to activate the internal butterfly damper.

- Australian made
- Adjustable closure



SKU	Model No.	Description	Duct Diameter	Ext. Size	Pack	Carton Qty	Barcode	S.S.P
	DJ150	DOWNJET OUTLET	150mm	240mm	Retail	6	9317468681100	30.00
	DJ200	DOWNJET OUTLET	200mm	290mm	Retail	6	9317468681117	42.00
	DJ250	DOWNJET OUTLET	250mm	340mm	Retail	6	9317468681124	74.00

Ceiling Diffuser



Features...

Commonly used for air intake, the design of these ceiling diffusers accepts air from surrounding surfaces and not directly below.

This makes it ideal for heat, smoke and vapour extraction/ transfer. For desired airflow control, simply screw the inverted cone centre.

- Australian made
- Adjustable closure



SKU	Model No.	Description	Duct Diameter	Ext. Size	Pack	Carton Qty	Barcode	S.S.P
	CD150	CEILING DIFFUSER/INTAKE	150mm	270mm	Retail	6	9317468671729	36.00
	CD200	CEILING DIFFUSER/INTAKE	200mm	320mm	Retail	6	9317468671736	44.00
	CD250	CEILING DIFFUSER/INTAKE	250mm	395mm	Retail	6	9317468671743	50.00
	CD300	CEILING DIFFUSER/INTAKE	300mm	440mm	Retail	6	9317468671712	78.00

Two way MDO Outlet



Allows for air flow to be directed to wherever it is required. All grills require an "M" series adaptor to match the supply duct. Grill sections can be removed for cleaning. External size on all vents is 50mm larger than hole size.

Features...

Two separate adjustable louvre sections.
For 150mm or 200mm ducting.
Add 50mm to hole size for face size.



SKU	Model No.	Description	Use Adaptors	Hole Size	Barcode	S.S.P
	MDO602	TWO WAY MDO OUTLET	M603 OR M604	230 x 230mm	9317468919753	42.00

Four way MDO Outlets



Features...

Four separate adjustable louvre sections.
For 150, 200, 250 or 300mm ducting.
Add 50mm to hole size for face size.



SKU	Model No.	Description	Use Adaptors	Hole Size	Barcode	S.S.P
	MDO601	FOUR WAY MDO OUTLET	M603 OR M604	230 x 230mm	9317468919760	44.00
	MDO611	FOUR WAY MDO OUTLET	M612, M613 OR M614	310 x 310mm	9317468919777	50.00
	MDO621	FOUR WAY MDO OUTLET	M622, M623 OR M614	360 x 360mm	9317468919784	62.00
	MDO631	FOUR WAY MDO OUTLET	M632 OR M633	395 x 395mm	9317468919791	82.00

Six way MDO Outlets



Features...

Six separate adjustable louvre sections.
For 400, 450 and 500mm ducting.
Add 50mm to hole size for face size.



SKU	Model No.	Description	Use Adaptors	Hole Size	Barcode	S.S.P
	MDO651	SIX WAY MDO OUTLET	M652 OR M653	360 x 535mm	9317468919807	102.00
	MDO641	SIX WAY MDO OUTLET	M642, M643 OR M644	390 x 585mm	9317468919814	105.00

Square Egg Crate Grill



Features...

Fixed grill vent for intake or exhaust air.
150, 200, 300, 350, 400 and 500mm.
Add 50mm to hole size for face size.



SKU	Model No.	Description	Use Adaptors	Hole Size	Barcode	S.S.P
	EG600	EGGCRATE GRILLS	M603 OR M604	230 x 230mm	9317468919821	40.00
	EG625	EGGCRATE GRILLS	M622, M623 OR M624	360 x 360mm	9317468919838	62.00
	EG655	EGGCRATE GRILLS	M652 OR M653	360 x 535mm	9317468919845	85.00

M Series Duct Adaptors



Features...

Clip on adaptors for attaching duct to the M.D.O vent.



SKU	Model No.	Description	Use With	Suits Duct	Barcode	S.S.P
	M603	DUCT ADAPTOR	MDO602, MDO601 OR EG600	150mm	9317468919852	12.00
	M604	DUCT ADAPTOR	MDO602, MDO601 OR EG600	200mm	9317468919869	12.00
	M612	DUCT ADAPTOR	MDO611	200mm	9317468919876	19.00
	M613	DUCT ADAPTOR	MDO611	250mm	9317468919883	19.00
	M614	DUCT ADAPTOR	MDO611	300mm	9317468919890	19.00
	M622	DUCT ADAPTOR	MDO621 OR EG625	300mm	9317468919906	21.00
	M623	DUCT ADAPTOR	MDO621 OR EG625	350mm	9317468919913	21.00
	M624	DUCT ADAPTOR	MDO621 OR EG625	400mm	9317468919920	21.00
	M632	DUCT ADAPTOR	MDO631	350mm	9317468919937	24.00
	M633	DUCT ADAPTOR	MDO631	400mm	9317468919944	24.00
	M642	DUCT ADAPTOR	MDO641	400mm	9317468919951	35.00
	M643	DUCT ADAPTOR	MDO641	450mm	9317468919968	35.00
	M644	DUCT ADAPTOR	MDO641	500mm	9317468919975	35.00
	M652	DUCT ADAPTOR	MDO651 OR EG655	400mm	9317468919982	35.00
	M653	DUCT ADAPTOR	MDO651 OR EG655	450mm	9317468919999	35.00

Xbase Return air grills



Features...

Manufactured in quality plastic, these combined with a mounting box or adaptor box (see right) can be used as a wall or ceiling air outlet.

- Removable grills for easy cleaning

Adaptor Box



Mounting Box



SKU	Model No.	Description	Colour	Hole Size	Barcode	S.S.P
	XRAG404	UNFILTERED	White	380 x 510mm	9317468931632	55.00
	XRAG414	FILTERED	White	380 x 510mm	9317468931649	78.00
	XRAG434	UNFILTERED	White	405 x 760mm	9317468931656	84.00
	XRAG444	FILTERED	White	405 x 760mm	9317468931663	104.00

Mounting Box

SKU	Model No.	Description	Hole Size	Barcode	S.S.P
	XRAG410	MOUNTING FRAME	380 x 510mm	9317468931670	35.00
	XRAG440	MOUNTING FRAME	405 x 760mm	9317468931687	43.00

Adaptor Box

SKU	Model No.	Description	Hole Size	Duct Size	Barcode	S.S.P
	XRAG425	ADAPTOR BOX	380 x 510mm	300mm	9317468931694	76.00
	XRAG426	ADAPTOR BOX	380 x 510mm	350mm	9317468931700	76.00
	XRAG427	ADAPTOR BOX	405 x 760mm	350mm	9317468931717	86.00
	XRAG428	ADAPTOR BOX	405 x 760mm	400mm	9317468931724	86.00

Grill Vent



Features...

Manufactured in quality stainless steel, these grill vents offer an attractive option for general ventilation applications. It is perfect for wall, ceiling or eave venting and can be used as both an air inlet or outlet.

- Suitable for internal or external use
- 304 Grade stainless steel



SKU	Model No.	Description	Size (W x H)	Pack	Carton Qty	Barcode	S.S.P
	RGV1309	GRILL VENT RECT.	130 x 90mm	Retail	6	9317468006668	11.50
	RGV1309B	GRILL VENT RECT.	130 x 90mm	Loose	24		10.00
	RGV1809	GRILL VENT RECT.	180 x 90mm	Retail	6	9317468006675	13.00
	RGV1809B	GRILL VENT RECT.	180 x 90mm	Loose	24		11.50
	RGV3009	GRILL VENT RECT.	300 x 90mm	Retail	6	9317468006682	17.50
	RGV3009B	GRILL VENT RECT.	300 x 90mm	Loose	24		16.00
	RGV1522	GRILL VENT RECT.	220 x 150mm	Retail	6	9317468006699	20.00
	RGV1522B	GRILL VENT RECT.	220x 150mm	Loose	24		18.50
	RGV1616	GRILL VENT RECT.	160 x 160mm	Retail	6	9317468006705	17.00
	RGV1616B	GRILL VENT RECT.	160 x 160mm	Loose	24		15.50
	RGV2020	GRILL VENT RECT.	200 x 200mm	Retail	6	9317468006712	22.50
	RGV2020B	GRILL VENT RECT.	200 x 200mm	Loose	24		21.00
	RGV2520	GRILL VENT RECT.	200 x 250mm	Retail	6	9317468006729	25.50
	RGV2520B	GRILL VENT RECT.	200 x 250mm	Loose	24		24.00
	RGV3704	GRILL VENT RECT.	370 x 40mm	Retail	6	9317468006736	14.50
	RGV3704B	GRILL VENT RECT.	370 x 40mm	Loose	24		13.00
	RGSS140	GRILL VENT ROUND	140mm Diam	Retail	6	9317468006644	14.00
	RVSS140B	GRILL VENT ROUND	140mm Diam	Loose	24		12.50
	RGSS190	GRILL VENT ROUND	190mm Diam	Retail	6	9317468006651	18.50
	RVSS190B	GRILL VENT ROUND	190mm Diam	Loose	24		17.00

Shut off control wall vent



Features...

Manufactured in quality stainless steel, this wall vent allows air to be shut off when not required.

- 304 Grade stainless steel



SKU	Model No.	Description	External Size	Pack	Carton Qty	Barcode	S.S.P
	SSDA93	SHUT OFF VENT	260 x 95mm	Loose	6	9317468001953	16.00
	SSDA96	SHUT OFF VENT	260 x 165mm	Loose	6	9317468001960	27.00
	SSDA99	SHUT OFF VENT	260 x 250mm	Loose	6	9317468001977	38.00

Door Grill Set

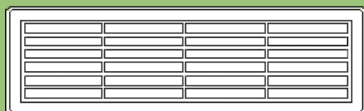

Features...

This door grill set is supplied with front and rear open style vents that allow for flow through ventilation. The 2 grills simply screw together for door mounting.

Ideal for bathrooms with extraction fans or for general ventilation.

- 2 x Screws included



SKU	Model No.	Description	Size	Ext. Size	Pack	Carton Qty	Barcode	S.S.P
	6145	DOOR VENT	435 x 75mm	451 x 89mm	2Pc set Retail	12	9317468061452	16.00
	6145B	DOOR VENT	435 x 75mm	451 x 89mm	Loose	24		14.00

Door vent open

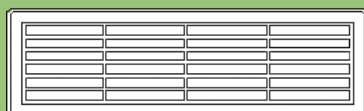

Features...

This larger sized, single-sided grill may be coupled with same for flow through door ventilation, or with below model (6150R) for adjustable closure option.

Ideal for bathrooms with extraction fans or for general ventilation.

- L465mm x W129mm Outer dimensions
- L430 x W93 x D18mm Rear flange dimensions



SKU	Model No.	Description	Size	Ext. Size	Pack	Carton Qty	Barcode	S.S.P
	6150	DOOR VENT OPEN	435 x 90mm	465 x 129mm	1Pc set Retail	6	9317468615006	15.00
	6150B	DOOR VENT OPEN	435 x 90mm	465 x 129mm	Loose	12		13.00

Door vent open/close

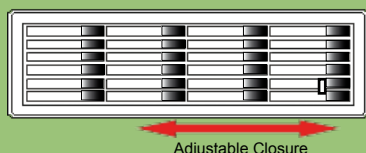

Adjustable Closure

Features...

This larger sized, single-sided grill has a simple slide control for airflow adjustment. It may be coupled with above model (6150) for flow through door ventilation.

Ideal for bathrooms with extraction fans or for general ventilation.

- White - ABS Plastic
- Adjustable closure control
- L465mm x W129mm Outer dimensions
- L430 x W92 x D18mm Rear flange dimensions



SKU	Model No.	Description	Size	Ext. Size	Pack	Carton Qty	Barcode	S.S.P
	6150R	DOOR VENT OPEN/CLOSE	435 x 90mm	465 x 129mm	1Pc Retail	12	9317468615013	18.00
	6150RB	DOOR VENT OPEN/CLOSE	435 x 90mm	465 x 129mm	Loose	12		16.00

Round Cupboard Vent



Features...

Multi-purpose, push-in round vent with horizontal or circular grills. Superior quality and strength to standard cupboard vents. Ideal breathing holes for appliances such as fridges and clothes dryers enclosed in cabinets and requiring ventilation.

- Flyscreen insert
- White - ABS Plastic



SKU	Model No.	Description	Outer Diameter	Rear flange diameter	Pack	Carton Qty	Barcode	S.S.P
	MV50/2BVS	ROUND VENT HORIZONTAL	60mm	48mm	2pk	40	9317468148504	4.50
	MV51/2BVS	ROUND VENT CIRCLE	60mm	48mm	2pk	40	9317468148511	4.50

Xbase Double sided door grill

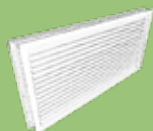

Features...

This door set has a streamline design suitable for larger, thicker doors.

- Suitable for doors 30-45mm thick
- Clip in mounting means no visible screw heads
- Made from Anodised aluminium

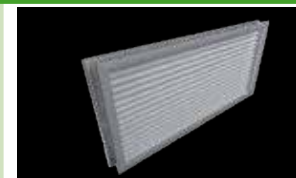

SKU	Model No.	Description	Dimensions	Barcode	S.S.P
	DG2406	DOUBLE SIDED DOOR GRILL	600mm x 150mm	9317468919685	128.60
	DG2408	DOUBLE SIDED DOOR GRILL	600mm x 200mm	9317468919692	149.00
	DG2410	DOUBLE SIDED DOOR GRILL	600mm x 250mm	9317468919708	168.40
	DG2412	DOUBLE SIDED DOOR GRILL	600mm x 300mm	9317468919715	184.50
	DG2416	DOUBLE SIDED DOOR GRILL	600mm x 400mm	9317468919722	248.00
	DG2418	DOUBLE SIDED DOOR GRILL	600mm x 450mm	9317468919739	278.00
	DG2424	DOUBLE SIDED DOOR GRILL	600mm x 600mm	9317468919746	312.00

Semi-Rigid Aluminium



Features...

Supplied in a compressed length this form of flexible ducting has a unique expanding design that offers efficient venting, as it holds it's shape and full diameter, even when bends are applied. Ideal for straight and indirect venting installations for clothes dryers, rangehoods, bathrooms and other general venting applications. To gain maximum length, use both hands to work in sections from the centre - out to either end.

- Temperature rating -70°C to +220°C
- Manufactured material thickness 0.89mm
- Complies with Australian Standards - AS1668.1
- 4 - Zero fire rating to Australian Standards - 1530.3



SKU	Model No.	Description	Diameter	Length	Pack	Carton Qty	Barcode	S.S.P
	AO4014MR	SEMI RIGID	100mm	1.4M	Retail	6	9317468040143	18.50
	AO5014MR	SEMI RIGID	125mm	1.4M	Retail	6	9317468050142	23.00
	AO6014MR	SEMI RIGID	150mm	1.4M	Retail	6	9317468060141	26.00
	AO48MX/9	SEMI RIGID	100mm	3M	Retail with two clamps	6	079916424019	37.50
	AO403MR	SEMI RIGID	100mm	3M	Retail	6	9317468004039	35.00
	AO503MR	SEMI RIGID	125mm	3M	Retail	6	9317468005036	42.00
	AO603MR	SEMI RIGID	150mm	3M	Retail	6	9317468006033	49.00

Semi-Rigid Aluminium Ducting without retail packaging

As Above.

Due to potential damage in transit, we can only supply loose Semi-Rigid Aluminium Ducting in full carton quantities.

If ordering AO403M only, it must be supplied in lots of 9 units.

However, if your order also includes larger sizes which are supplied 4 per carton, then we can ship AO403M inside the larger ones in lots of 4.

Less than full carton quantities are available in protective retail packaging at a higher cost as listed above.

SKU	Model No.	Description	Diameter	Length	Pack	Barcode	S.S.P
	AO403M	SEMI RIGID	100mm	3M	9 Pieces per carton		31.00
	AO503M	SEMI RIGID	125mm	3M	4 Pieces per carton		38.00
	AO603M	SEMI RIGID	150mm	3M	4 Pieces per carton		45.00
	AO803M	SEMI RIGID	200mm	3M	4 Pieces per carton	079916424095	68.00

SUPURR-FLEX® Metallic Duct



Features...

Ideally suited for straight venting applications this retail packed range of multi-layered, metallic duct offers superior temperature ratings and flame resistant protection.

SUPURR-FLEX is a multiple use ducting that can be used for exhaust venting of bathrooms, rangehoods, electric clothes dryers and many other applications. Stretch SUPURR-FLEX ducting taut to gain optimum airflow efficiency.

- Temperature Rating -18°C to +130°C
- Complies with Australian Standards - AS1668.1
- 4 - Zero fire rating to Australian Standards - AS1530.3



SKU	Model No.	Description	Diameter	Length	Pack	Carton Qty	Barcode	S.S.P
	FO408B	SUPURR-FLEX	100mm	2.4M	Retail	6	079916430485	20.00
	FO503M	SUPURR-FLEX	125mm	3.6M	Retail	6	9317468655033	30.00
	FO603M	SUPURR-FLEX	150mm	3.6M	Retail	6	9317468656030	32.00
	FO803M	SUPURR-FLEX	200mm	3.6M	Retail	6	9317468658034	45.00
	FUL0425	SUPURR-FLEX	100mm	7.6M	Retail	6	079916435015	50.00
	FUL0525	SUPURR-FLEX	125mm	7.6M	Retail	6	079916435022	58.00
	FUL0625	SUPURR-FLEX	150mm	7.6M	Retail	6	079916435039	62.00
	FUL0825	SUPURR-FLEX	200mm	7.6M	Retail	6	079916435053	82.00

"Clip-Seam" Solid Duct

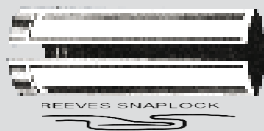

Features...

Made from 30 gauge, galvanised steel - this unique "Clip-Seam" has a smooth internal finish for maximum airflow efficiency. Once on site, insert both seams together at one end and work up the length to form a solid pipe. It works well with our mushroom cowls as a roof penetration pipe.

- Crimped end offers a male connection to pipe or ducting

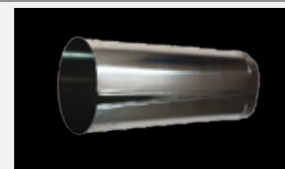

SKU	Model No.	Description	Diameter	Length	Barcode	S.S.P
	GSPS042430	CLIP-SEAM PIPE	100mm	610mm	079916901152	14.00
	GSPS052430	CLIP-SEAM PIPE	125mm	610mm	079916930008	16.00
	GSPS062430	CLIP-SEAM PIPE	150mm	610mm	079916901169	18.50
	GSPS082430	CLIP-SEAM PIPE	200mm	610mm	079916901183	24.00
	PPS04430	CLIP-SEAM PIPE	100mm	1.2M	079916005614	24.00
	PPS05430	CLIP-SEAM PIPE	125mm	1.2M	079916005621	28.00
	PPS06430	CLIP-SEAM PIPE	150mm	1.2M	079916005638	33.00
	PPS08430	CLIP-SEAM PIPE	200mm	1.2M	079916005645	42.00

Insulated Duct



Features...

Silver/black core ducting surrounded by white polyester insulation. Supplied in a strong, silver foil outer sleeve to help minimise the effects of external conditions on internal duct temperatures.

- Complies with AS/NZS 4859.1
- Insulated with allergan free polyester fibre
- Encased in reflective metallic foil to reduce radiant heat gain
- Australian Made
- Supplied in compressed HD plastic bag
- 10 year warranty

*Hint - Keep internal ducting taut for maximum airflow efficiency.

- Use Rt 0.6 Thermal rating for warm or cool air transfer where there is no direct connection to a heater or cooler.
- Use Rm 1.0 thermal rated ducting when there is no direct connection to a heater or cooler and the ceiling floor or wall space is enclosed.
- Use Rm 1.5 thermal rated ducting when there is direct connection to a heater or cooler and the ceiling floor or wall space is not enclosed in alpine areas.

** Please note: 350, 400, 450 & 500mm diameters are available by special quotation.



Insulated Duct

R 0.6 INSULATED

SKU	Model No.	Description	Diameter	Length	Barcode	S.S.P
	D603M	INSULATED DUCT	150mm	3M	9317468606035	27.00
	D803M	INSULATED DUCT	200mm	3M	9317468608039	34.00
	D1003M	INSULATED DUCT	250mm	3M	9317468610032	41.00
	D1203M	INSULATED DUCT	300mm	3M	9317468612036	48.00
	D606M	INSULATED DUCT	150mm	6M	9317468606066	51.00
	D806M	INSULATED DUCT	200mm	6M	9317468608060	64.00
	D1006M	INSULATED DUCT	250mm	6M	9317468610063	79.00
	D1206M	INSULATED DUCT	300mm	6M	9317468612067	93.00

Insulated Duct

R 1.0 INSULATED

SKU	Model No.	Description	Diameter	Length	Barcode	S.S.P
	D606M+	INSULATED DUCT	150mm	6M	9317468065337	82.00
	D806M+	INSULATED DUCT	200mm	6M	9317468065344	102.00
	D1006M+	INSULATED DUCT	250mm	6M	9317468065375	124.00
	D1206M+	INSULATED DUCT	300mm	6M	9317468065382	145.00

Insulated Duct

R 1.5 INSULATED

SKU	Model No.	Description	Diameter	Length	Barcode	S.S.P
	D606M++	INSULATED DUCT	150mm	6M	9317468065399	142.00
	D806M++	INSULATED DUCT	200mm	6M	9317468065405	170.00
	D1006M++	INSULATED DUCT	250mm	6M	9317468065412	204.00
	D1206M++	INSULATED DUCT	300mm	6M	9317468065429	238.00

Features...

Our tile roof flashing has been designed specifically for residential use and meets virtually all roofing needs. With a built in 20 degree pitch it is adaptable to almost any roof pitch (including 45 degrees). Sleeve flexibility accommodates vibration and pipe movement caused by expansion/contraction. The soft, flexible, aluminium base easily conforms to roof tile profiles.

- 20 Year warranty
- 20° pitch
- Fire retardant
- EPDM rubber with aluminium base
- Temperature rating -50°C to +115°C

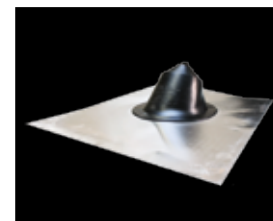
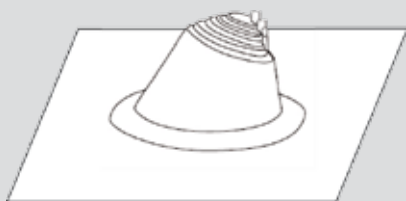

SKU	Model No.	Description	Pipe Size	Base Size	Barcode	S.S.P
	SDA100B	DEKTITE MICRO	12-70mm	500 x 600mm	-	43.00
	SDA101B	DEKTITE NO. 1	50-70mm	500 x 600mm	-	46.00
	SDA102B	DEKTITE NO.2	110-200mm	600 x 600mm	-	108.00
	SDA103B	DEKTITE NO. 3	160-300mm	764 x 764mm	-	118.00
	SDA104B	DEKTITE NO. 4	300-400mm	956 x 956mm	-	186.00

FLASHING - METAL ROOF

Features...

Our Metal Roof Flashing has a flexible design which meets virtually all roofing needs. Made of EPDM, this flashing is designed specifically for the harsh Australian sun, providing maximum resistance to weathering due to ozone and ultraviolet light. Easy onsite customization allows for quick installation. The flexible, soft aluminium base is designed to form a seal on most panel configurations and roof pitches regardless of pipe location.

- 20 Year warranty
- EPDM rubber with Aluminium trim
- Temperature rating -50°C to +115°C
- One piece construction
- Square base
- Black

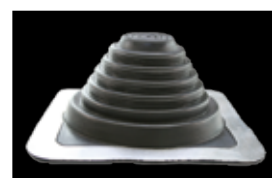

SKU	Model No.	Description	Pipe Size	Base Size	Barcode	S.S.P
	DFE100B	DEKTITE MINI	0-35mm	100 x 100mm	-	10.50
	DFE101B	DEKTITE NO. 1	5-55mm	139 x 139mm	-	12.60
	DFE102B	DEKTITE NO. 2	50-70mm	178 x 178mm	-	19.00
	DFE103B	DEKTITE NO. 3	5-127mm	221 x 221mm	-	20.90
	DFE104B	DEKTITE NO. 4	75-175mm	280 x 280mm	-	26.00
	DFE105B	DEKTITE NO. 5	100-200mm	310 x 310mm	-	32.50
	DFE106B	DEKTITE NO. 6	125-230mm	363 x 363mm	-	45.00
	DFE107B	DEKTITE NO. 7	150-300mm	456 x 456mm	-	55.00
	DFE108B	DEKTITE NO. 8	170-355mm	496 x 496mm	-	81.00
	DFE109B	DEKTITE NO. 9	230-508mm	681 x 681mm	-	121.00

Clamps on a Roll & Locking devices

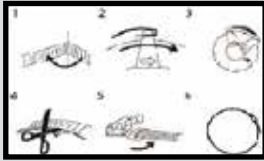

Features...

- 30M x 9mm x 0.6mm Roll of stainless steel band in pre-calibrated ABS dispenser
- Stainless steel AISI 430
- Use with SCA - Clamp locking device
- For use with CRA - Clamps on a roll
- Upper and lower housing: Low carbon steel nickel plated
- Locking mechanism: Stainless steel AISI 430
- Screw: 7mm cross slotted hex head in galvanised steel
- Clamp Packing: Box of 50 in 2 bags of 25



SKU	Model No.	Description	Length	Barcode	S.S.P
	CRA	S/S CLAMP BAND ON ROLL	30M	9317468779166	55.00
	SCA	S/S CLAMP BAND LOCKING SCREWS	50PK	9317468779173	55.00

Metal Worm Drive Clamps



Features...

The metal worm drive clamp are the most professional way to secure any ducting. Eliminates the use of tape or cable ties that over time, can become loose with excessive air pressures, temperatures or condensation.

To use - Simply loosen the clamp with a screwdriver or 1/4" hex driver, slip the clamp over the ducting, position correctly and tighten screw firmly in a clockwise direction.
To remove - Simply rotate the screw in an anti-clockwise direction.

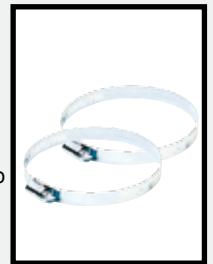

SKU	Model No.	Description	Diameter	Pack	Carton Qty	Barcode	S.S.P
	MC4/2	WORM DRIVE DUCT CLAMP	Up to 114mm	Retail 2 pk	6	9317468671446	8.00
	MC5/2	WORM DRIVE DUCT CLAMP	Up to 139mm	Retail 2 pk	6	9317468671453	8.50
	MC6/2	WORM DRIVE DUCT CLAMP	Up to 165mm	Retail 2 pk	6	9317468671460	9.50
	MC8/2	WORM DRIVE DUCT CLAMP	Up to 216mm	Retail 2 pk	6	9317468671385	13.50

Metal Worm Drive Clamps BULK PACKS

Features...

As Above.
Full carton Supply only.
Less than full carton quantities available in retail packs of 2 as listed above.

SKU	Model No.	Description	Diameter	Carton	Barcode	S.S.P
	MC450	WORM DRIVE DUCT CLAMP	Up to 114mm	50		3.00
	MC525	WORM DRIVE DUCT CLAMP	Up to 139mm	25		3.50
	MC625	WORM DRIVE DUCT CLAMP	Up to 165mm	25		4.00
	MC812	WORM DRIVE DUCT CLAMP	Up to 216mm	12		5.00

Duct Connectors



Features...

Made in Australia, this range of duct connecting sleeves are used to extend the length of a venting application.

Manufactured in galvanised steel for protection against fire and corrosion. Used to connect 2 pieces of Semi-Rigid or SUPurr-FLEX® ducting.

Simply place a matching size metal worm drive clamp over the end of the ducting, insert one end of the sleeve into the ducting, position the clamp and tighten.

Do the same for the other side.



SKU	Model No.	Description	Diameter	Ext Size	Carton Qty	Barcode	S.S.P
	DAC4	DUCT CONNECT SLEEVE	100mm	110 x 100mm	6	079916200101	8.00
	DAC5	DUCT CONNECT SLEEVE	125mm	110 x 125mm	6	079916931555	9.00
	DAC6	DUCT CONNECT SLEEVE	150mm	110 x 150mm	6	079916202020	10.00
	DAC8	DUCT CONNECT SLEEVE	200mm	150 x 200mm	6	079916200224	12.00
	DAC10	DUCT CONNECT SLEEVE	250mm	150 x 250mm	6	9317468931946	14.00
	DAC12	DUCT CONNECT SLEEVE	300mm	150 x 300mm	6	9317468931953	16.00

Increasesers/Reducers



Features...

Designed in gradual-staged sections to minimise back flow pressures when reducing diameters.

Ideal for increasing/decreasing ducting diameters

May be used in conjunction with Clip-seam piping

- Internally smooth for maximum airflow efficiency
- May be clamped for ducting - or riveted for pipe attachment



SKU	Model No.	Description	Joins	Ext. Size	Made from	Carton Qty	Barcode	S.S.P
	DIRB54	DUCT INCREASER	100 - 125mm	L150mm	Aluminium	12	079916908229	8.50
	DIRB65	DUCT INCREASER	125 - 150mm	L150mm	Aluminium	6	079916908250	12.50
	DIRB86	DUCT INCREASER	150 - 200mm	L180mm	Galvanised steel	6	079916908281	26.00

Adjustable Elbows 0-90°

Galvanised Steel

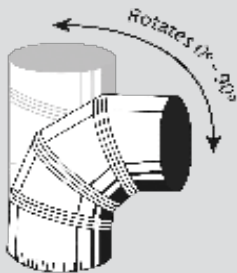

Features...

Clever by design - each sections rotates to create various shapes and angles from 0 to 90 degree bends.

May be used in conjunction with Clip-seam piping

Flexible ducting may be attached on the crimped end.

- Made in 30g. Galv. steel for protection against fire and corrosion.
- Crimped end for Clip-seam pipe or ducting connection
- May be clamped for ducting - or riveted for pipe attachment



SKU	Model No.	Description	Diameter	Made From	Carton Qty	Barcode	S.S.P
	ELB049030	ADJUST ELBOW 0-90DEG	100mm	Galvanised steel	12	079916901817	17.00
	ELB059030	ADJUST ELBOW 0-90DEG	125mm	Galvanised steel	12	079916930329	29.00
	ELB069030	ADJUST ELBOW 0-90DEG	150mm	Galvanised steel	12	079916901831	37.00
	ELB089030	ADJUST ELBOW 0-90DEG	200mm	Galvanised steel	12	079916901855	47.00

Draft Blocker Galvanised Steel

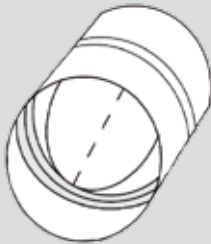

Features...

Manufactured with an internal, spring-loaded butterfly damper that allows air to flow through in one direction and close when the venting system is not in use.

These in-line draft blockers are ideally installed in vertical venting systems such as rangehoods, exhausting out through the roof.

*Hint - Install at regular intervals to ensure there is no blockage.



SKU	Model No.	Description	Duct diameter	Ext. Size	Made from	Carton Qty	Barcode	S.S.P
	DBV100	DRAFT BLOCKER VALVE	100mm	88 x 100mm	Galvanised steel	24	9317468004657	17.50
	DBV125	DRAFT BLOCKER VALVE	125mm	88 x 125mm	Galvanised steel	24	9317468004664	19.50
	DBV150	DRAFT BLOCKER VALVE	150mm	88 x 150mm	Galvanised steel	12	9317468004671	22.50
	DBV200	DRAFT BLOCKER VALVE	200mm	88 x 200mm	Galvanised steel	12	9317468004688	27.50

Deflect-o Vent Brush

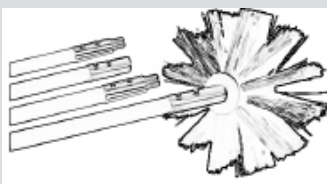

Features...

This brush is designed to keep your ducting lint free saving energy, increasing efficiency and preventing dangerous fires. It has three detachable rods that can bend around ducting for efficient cleaning.

- Includes 2.4M flexible rods
- A drill can be attached to the rod end for more effective cleaning
- Easy to use

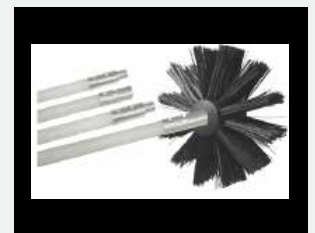

SKU	Model No.	Description	Carton Qty	Barcode	S.S.P
	DVBRUSH8	VENT BRUSH	6	079916024424	24.00

Stack - A - Bin Storage System



Features...

Useful storage and organisation of smaller items in a handy stackable unit.

- Modular units with stackable design
- Mix & match colours and sizes to create your own custom storage system
- Manufactured using High Impact Polystyrene Plastic (HIPS)
- Transparent bins keep supplies visible
- Supplied with product bin labels for easy identification
- Food grade plastic suitable for use in hospitals, retail stores, restaurants, garages, warehouses, vans, merchandising systems and much more
- Available in white, black and blue



90903, 90904, 90905



90603, 90604 90605



90503, 90504 90505

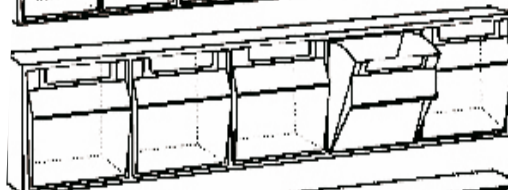

90403, 90404 90405

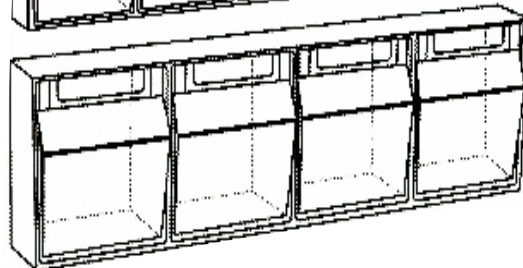

SKU	Model No.	No. of Bins	Description	Dimensions W x H x D	Barcode	S.S.P
	90403	4	STACK-A-BIN Storage System White	600 x 210 x 170mm	9317468931731	85.00
	90444	4	STACK-A-BIN Storage System Black	600 x 210 x 170mm	9317468931748	85.00
	90405	4	STACK-A-BIN Storage System Blue	600 x 210 x 170mm	9317468931755	85.00
	90503	5	STACK-A-BIN Storage System White	600 x 166 x 137mm	9317468931762	60.00
	90504	5	STACK-A-BIN Storage System Black	600 x 166 x 137mm	9317468931779	60.00
	90505	5	STACK-A-BIN Storage System Blue	600 x 166 x 137mm	9317468931786	60.00
	90603	6	STACK-A-BIN Storage System White	600 x 116 x 95mm	9317468931793	40.00
	90604	6	STACK-A-BIN Storage System Black	600 x 116 x 95mm	9317468931809	40.00
	90605	6	STACK-A-BIN Storage System Blue	600 x 116 x 95mm	9317468931816	40.00
	90903	9	STACK-A-BIN Storage System White	600 x 80 x 64mm	9317468931823	30.00
	90904	9	STACK-A-BIN Storage System Black	600 x 80 x 64mm	9317468931830	30.00
	90905	9	STACK-A-BIN Storage System Blue	600 x 80 x 64mm	9317468931847	30.00

Link-A-Bin Storage System



Features...

Design your own storage unit with large or small options and link together as required.

- Modular units with unique linking design enables you to link individual units vertically and/or horizontally
- Individual bins are great for tight spaces
- Manufactured using High Impact Polystyrene Plastic (HIPS)
- Transparent bins keep supplies visible
- Supplied with product bin labels for easy identification
- Food grade plastic suitable for use in hospitals, retail stores, restaurants, garages, warehouses, vans, merchandising systems and much more
- Available in white, black and blue

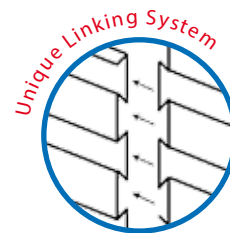

Model No.	No. of Bins	Description	Dimensions W x H x D	Barcode	S.S.P
91503	1	LINK-A-BIN Storage System White - Large	123 x 163 x 135mm	9317468931854	16.00
91504	1	LINK-A-BIN Storage System Black - Large	123 x 163 x 135mm	9317468931861	16.00
91903	1	LINK-A-BIN Storage System White - Small	72 x 77 x 64mm	9317468931878	6.00
91904	1	LINK-A-BIN Storage System Black - Small	72 x 77 x 64mm	9317468931885	6.00

deflect-o® Tilt-Bin™ Storage System



Features...

Design your own storage unit with as many storage boxes as you like in varying sizes.

- Modular units feature a unique interlocking feature. Mix and match various sizes to create your own display
- Supplied with mounting hardware and bin labels
- Clear removable bins keeps supplies visible
- Individual bins tilt out effortlessly

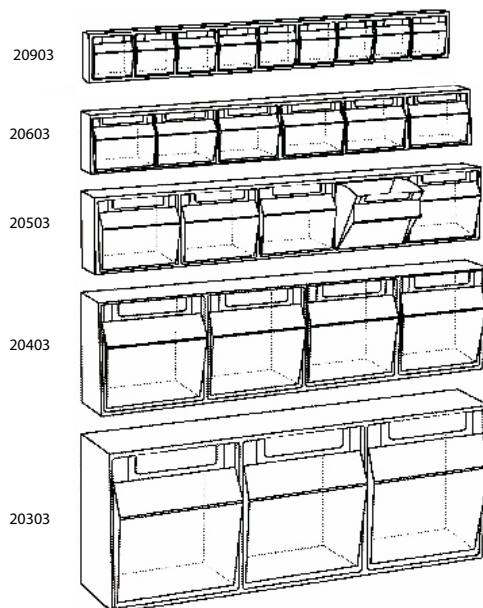
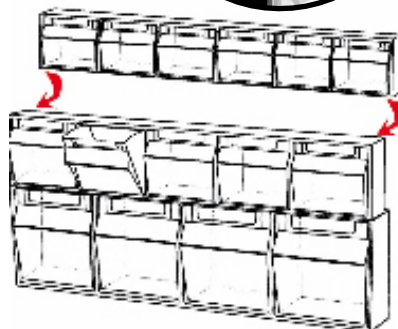

SKU	Model No.	No. of Bins	Description	Dimensions W x H x D	Carton Qty	Barcodes	S.S.P
	20303	3	Tilt-Bin™ Storage System White *	600 x 240 x 200mm	4	9317468931892	130.00
	20403	4	Tilt-Bin™ Storage System White *	600 x 210 x 170mm	6	9317468931908	110.00
	20503	5	Tilt-Bin™ Storage System White *	600 x 165 x 135mm	6	9317468931915	95.00
* A limited quantity of black also available contact our office for more details							
	20603	6	Tilt-Bin™ Storage System White	600 x 115 x 95mm	12	9317468931922	50.00
	20903	9	Tilt-Bin™ Storage System White	600 x 85 x 65mm	12	9317468931939	32.00

MODEL NO.	PAGE	MODEL NO.	PAGE	MODEL NO.	PAGE	MODEL NO.	PAGE
50	23	D12108-I	26	D866-I	26	DVSS100	28
51	23	D201	21	D886	26	DVSS100B	28
67	23	D202	21	D886-I	26	DVSS125	28
99	23	D203	21	D888	26	DVSS125B	28
6145	34	D204	21	DAC10	38	DVSS150	28
6145B	34	D205	21	DAC12	38	DVSS150B	28
6150	34	D206	21	DAC4	38	DVSS200B	28
6150B	34	D207	21	DAC5	38	DVSSC	15
6150R	34	D208	21	DAC6	38	DVSU	15
6150RB	34	D209	21	DAC8	38	DVSWi	15
361TAPE	14	D210	21	DAF2	18	DVSWO	15
AMK1	19	D211	21	DAF3	18	DVSWP	15
AMK2	19	D212	21	DAIW	18	DY1088	26
AO4014MR	35	D213	21	DB4K	16	DY1088-I	26
AO403M	35	D214	21	DBV100	9 & 39	DY644	26
AO403MR	35	D215	21	DBV125	9 & 39	DY644-I	26
AO48MX/9	35	D216	21	DBV150	9 & 39	DY866	26
AO5014MR	35	D217	21	DBV200	9 & 39	DY866-I	26
AO503M	35	D218	21	DG2406	34	EG600	32
AO503MR	35	D219	21	DG2408	34	EG625	32
AO6014MR	35	D220	21	DG2410	34	EG655	32
AO603M	35	D221	21	DG2412	34	ELB049030	39
AO603MR	35	D222	21	DG2416	34	ELB059030	39
AO803M	35	D223	21	DG2418	34	ELB069030	39
BV04	23	D224	21	DG2424	34	ELB089030	39
BV05	23	D225	21	DIRB54	9, 11 & 39	EVE	29
BV06	23	D226	21	DIRB65	9, 11 & 39	EVSS100	30
BV09	23	D227	21	DIRB86	9 & 39	EVSS100B	30
BV10	23	D228	21	DJ150	20 & 31	EVSS125	30
CD150	31	D229	21	DJ200	20 & 31	EVSS125B	30
CD200	20 & 31	D230	21	DJ250	20 & 31	EVSS150	30
CD250	31	D231	21	DK4E	17	EVSS150B	30
CD300	31	D232	21	DK4R	17	EVSS200B	30
CDSS100	31	D233	21	DK4W	17	FDK150	25
CDSS125	31	D234	21	DMR1217	24	FLSS100B	28
CDSS150	31	D235	21	DMR1228	24	FLSS125B	28
CDSS200B	31	D236	21	DMRBRASS	24	FLSS150B	28
CRA	38	D237	21	DMRCHROME	24	FLSS200B	28
D1003M	36	D238	21	DP411S	27	FO408B	35
D1006M	36	D239	21	DV4A	16	FO503M	35
D1006M+	36	D240	21	DVBRUSH8	39	FO603M	35
D1006M++	36	D301	25	DVS1	13	FO803M	35
D10108	26	D302	25	DVS1SS	13	FUL0425	35
D10108-I	26	D303	25	DVS2	12	FUL0525	35
D1086	26	D304	25	DVS3	12	FUL0625	35
D1086-I	26	D603M	36	DVS4	13	FUL0825	35
D1088	26	D606M	36	DVS5	12	GSPS042430	36
D1088-I	26	D606M+	36	DVS6	13	GSPS052430	36
D1203M	36	D606M++	36	DVSA	14	GSPS062430	36
D1206M	36	D666-I	36	DVSC	14	GSPS082430	36
D1206M+	36	D803M	36	DVSD	14	GVSS100	28
D1206M++	36	D806M	36	DVSE	14	GVSS100B	28
D121010	26	D806M+	36	DVSGR	14	GVSS125	28
D121010	26	D806M++	36	DVSi	14	GVSS125B	28
D12108	26	D866	26	DVSO	15	GVSS150	28

MODEL NO.	PAGE
GVSS150B	28
GVSS200B	28
HGV4	29
HGV4WJ	29
HGV5	29
HGV5WJ	29
HGV6	29
HGV6WJ	29
HS4W	27
HS4WJ	27
HS5W	27
HS6W	27
HSM4W	29
HSM4WR	29
HSM5W	29
HSM5WR	29
HSM6W	29
HSM6WR	29
HSR4W	27
HSR5W	27
HSR6W	27
HTK1	19
HTK2	19
HVSS100	28
HVSS100B	28
HVSS125	28
HVSS125B	28
HVSS150	28
HVSS150B	28
IF150	20
IMA100	30
IMA125	30
IMA150	30
LF RHKW	11
LR150E	19
LR150ESS	19
LR150W	19
LR150WSS	19
LTF	16
LTKA	16
M603	32
M604	32
M612	32
M613	32
M614	32
M622	32
M623	32
M624	32
M632	32
M633	32
M642	32
M643	32
M644	32
M652	32
M653	32

MODEL NO.	PAGE
MC4I2	38
MC450	38
MC5I2	38
MC525	38
MC6I2	38
MC625	38
MC8I2	38
MC812	38
MCH100	30
MCH125	30
MCH150	30
MCH200	30
MDO601	32
MDO602	32
MDO611	32
MDO621	32
MDO631	32
MDO641	32
MDO651	32
MFAL1B	37
MFAL2B	37
MFAL3B	37
MFALMINIB	37
MFS1B	37
MFS2B	37
MFS3B	37
MFS4B	37
MFS5B	37
MFS6B	37
MFS7B	37
MFS8B	37
MFS9B	37
MFSMAXIB	37
MFSMINIB	37
MV100BVS	29
MV100PFS	31
MV125BVS	29
MV125PFS	31
MV150BVS	29
MV150PFS	31
MV200	27
MV200PFS	31
MV250PFS	31
MV50/2BVS	34
MV51/2BVS	34
MVANTBRAS	24
MVBROWN	24
MVCHAR	24
MVCHOC	24
MVGREY	24
MVICANTBRASS	24
MVICBLACK	24
MVICCHROME	24
MVICNICK	24
MVICPBRASS	24

MODEL NO.	PAGE
MVICWHITE	24
MVLTBEIGE	24
MVNICK	24
MVWHITE	24
PPS04430	36
PPS05430	36
PPS06430	36
PPS08430	36
RCT	30
RF41203	22
RF41213	22
RF41217	22
RF41218	22
RF41226	22
RF41228	22
RF41239	22
RF41244	22
RF41249	22
RF41253	22
RF41256	22
RF41259	22
RGSS140	33
RGSS140B	33
RGSS190	33
RGSS190B	33
RGV1309	33
RGV1309B	33
RGV1522	33
RGV1522B	33
RGV1616	33
RGV1616B	33
RGV1809	33
RGV1809B	33
RGV2020	33
RGV2020B	33
RGV2520	33
RGV2520B	33
RGV3009	33
RGV3009B	33
RGV3704	33
RGV3704B	33
RHA5	4
RHF5R	4
RHF6R	4
RHK125E	5
RHK125ESS	5
RHK125T	7
RHK125W	8
RHK125WSS	8
RHK150E	5
RHK150ESS	5
RHK150T	7
RHK150W	8
RHK150WSS	8
RHK200ESS	5

MODEL NO.	PAGE
RHK200T	7
RHK200W	8
RHK200WSS	8
RHKE65	9
RHKMR65	6
RHKTR65	6
RIMA	30
RMC4	30
RMC5	30
RMC6	30
RMC8	30
SCA	38
SSDA93	33
SSDA96	33
SSDA99	33
SSE204	11
SVCHW4F	17
TFG4	31
TFG6	20 & 31
TILT BINS	40 & 41
VKC150-1	10
VKC150-2	10
VKC204-1	10
VKC204-2	10
VKC5601	11
VKC5605	10
VKC5608	10
VKC5610	11
VKC5612	10
VKC5613	11
VKC5616	10
VKC5630	11
VKC650	11
VKC652	10
VKC653	10
VKC654	10
VKC657	11
VKC660	10
VKC664	11
VKC670	10
VKC6546	10
VKC5626	10
WOODPOLOAK	24
WOODUNFOAK	24
XRAG404	33
XRAG410	33
XRAG414	33
XRAG425	33
XRAG428	33
XRAG427	33
XRAG428	33
XRAG343	33
XRAG440	33
XRAG444	33



Proud Distributors of the Following Leading Brands...



Distributed By:

**JPM International Pty Ltd
23 Power Road
Bayswater, Victoria 3153
Australia**

**Phone: (03) 9729 9777
Freecall: 1800 859 956
Facsimile: (03) 9729 3022
Email: info@jpmark.com.au**

www.jpmark.com.au